

# ELCO Furniture

## Product catalogue 2024

### Inserts

<a href="#">CLASSIC</a>	3
<a href="#">COMFORT</a>	4
<a href="#">CONCEPT</a>	5
<a href="#">FLEXLINE</a>	6
<a href="#">FLEXYTRAY CLASSIC</a>	7
<a href="#">SPICY</a>	8
<a href="#">SPRING</a>	9
<a href="#">TOP SORT</a>	10
<a href="#">VISIO</a>	11
<a href="#">WATCH</a>	12
<a href="#">WINGS</a>	13

### Accessories & Additio-

<a href="#">SOCKET HOUSING</a>	31
<a href="#">PLASTIC GUIDES</a>	32
<a href="#">LUXUS</a>	33
<a href="#">AIR</a>	34

### Drawers

<a href="#">SINUS</a>	15
<a href="#">SUPERKLICK</a>	16
<a href="#">STECKSYSTEM</a>	17
<a href="#">TOP VOLUME</a>	18
<a href="#">TOP KÄSTEN KITCHEN</a>	19
<a href="#">TOP KÄSTEN BATH</a>	20
<a href="#">PLASTIC GUIDES</a>	21

### Waste bin

<a href="#">CASE SELECT</a>	23
<a href="#">CASE SELECT LEVEL</a>	24

### Non-sliding mats

<a href="#">MAGIC PEARL</a>	26
<a href="#">MAGIC SCRATCH</a>	27
<a href="#">MAGIC SLIM</a>	28
<a href="#">TOP ROLL GROOVE</a>	29

# ELCO Inserts





## SKT 400

SKT 400	H	W min.	W max.	D min.	D max.
K0 300	50	176	299	395	446
K0 400	50	301	399	395	446
K0 500	50	401	499	395	446
K0 600	50	501	559	395	446

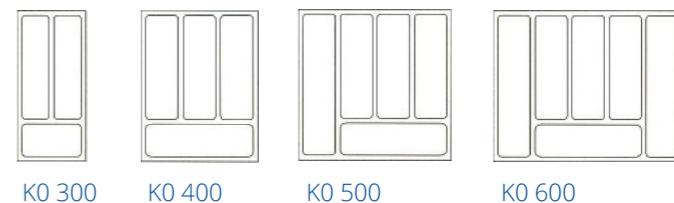

## SKT 500

SKT 500	H	W min.	W max.	D min.	D max.
K0 300	50	176	299	446	496
K0 350	50	201	299	437	496
K0 400	50	301	399	437	496
K0 450	50	350	399	437	496
K0 500	50	401	499	437	496
K0 600	50	501	559	437	496



For many years now, the CLASSIC cutlery tray can be found in kitchens, as it is an expression of a timeless kitchen design and of the highest quality. The evenly spaced compartments and its classic alignments allow it to be used even in changing trends. Due to the complex injection moulding process, the sensitive inner corners receive a secure stability against any damage.

The partitions are designed to meet the classic requirements for storing cutlery, and the corners are easy to clean. The CLASSIC series can individually be adapted to the frame systems commonly used on the market and is reliably supplied as a completely finished product.

- Made by injection moulding
- Ideal utilization of the drawer in the kitchen cabinet
- Classic alignments
- Cleanable radius
- Classic, linear compartment layout
- Etched surfaces in the base area for high scratch resistance
- Flexible use in all common drawer and cabinet types



# COMFORT



The COMFORT cutlery tray series is characterised by its calming, high-quality design. The compartments are sensibly coordinated and allow an optimum organisation of utensils and accessories in a harmonious fibre look at all times. The COMFORT cutlery tray series can be described as classic. It has been established in the kitchen industry for years. The resistant plastic with a modern structured surface withstands daily use without any restriction.

The COMFORT series can be adapted to any frame system individually. It is commonly used in the market and is supplied reliably and accordingly as a completely finished product.



- Ideal use in a drawer of a kitchen cupboard
- Ergonomic design with sloping partitioning
- Available in all standard forms
- Classic, straight-lined compartment layout
- Filigree, strikingly tapered compartment walls
- Flexible use in all standard drawer and cupboard types
- Large range width
- Made of resistant plastic

## SKT 350

SKT 350	H	W min.	W max.	D min.	D max.
K0 400	50	301	410	360	390
K0 450	50	301	410	360	390
K0 500	50	401	510	360	390
K0 600	50	501	560	360	390

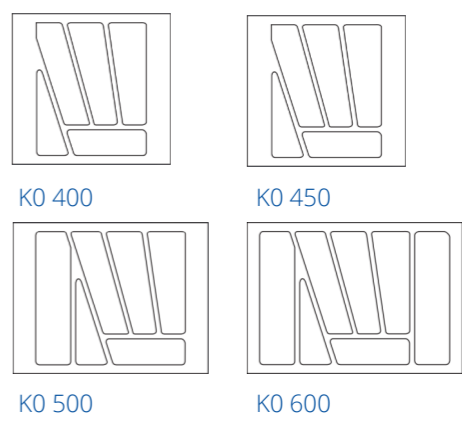

## SKT 400

SKT 400	H	W min.	W max.	D min.	D max.
K0 300	50	201	290	390	440
K0 400	50	301	340	390	440
K0 450	50	351	390	390	440
K0 500	50	401	490	390	440
K0 600	50	501	540	390	440
K0 800	50	701	860	390	440
K0 900	50	701	860	390	440

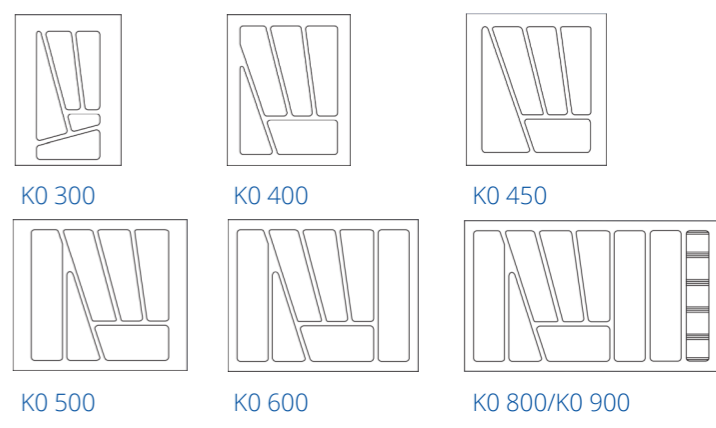

## SKT 500

SKT 500	H	W min.	W max.	D min.	D max.
K0 300	50	201	290	440	540
K0 400	50	301	340	440	540
K0 450	50	351	390	440	540
K0 500	50	401	490	440	540
K0 600	50	501	540	440	540
K0 800	50	701	760	440	540
K0 900	50	801	960	440	540
K0 1000	50	801	960	440	540

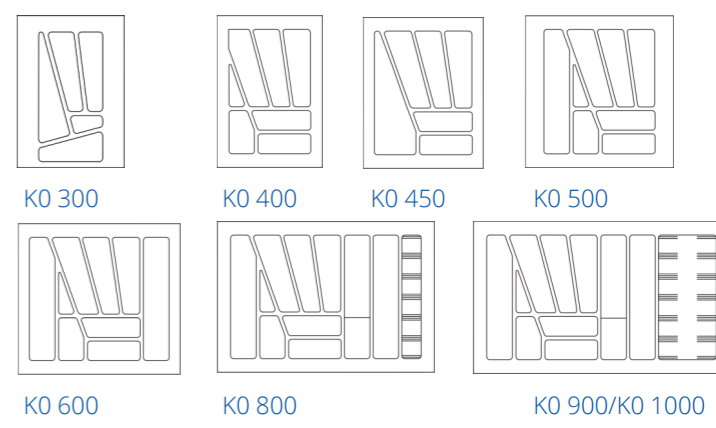

# CONCEPT



The increasingly filigree, high-quality drawer frames also pose a challenge to the producers of accessories. With its CONCEPT cutlery insert system, ELCO has taken this as its starting point and developed a product that pushes the limits of what is practicable in thermoforming. The result is an insert with the smallest radii and very thin racks. CONCEPT speaks the language of current design trends in kitchen furnishings.

Moreover, CONCEPT is practical in its service. With logically arranged compartments, homogeneously and value-based to the requirements in the household. The resistant plastic withstands a daily use without restriction but with a modern structured surface. The CONCEPT series can be adapted to any frame system individually. It is commonly used in the market and is supplied reliably and accordingly as a completely finished product.

- Optimum use of the drawer in the kitchen cabinet
- Smallest racks widths
- Smallest radii
- Easy to clean
- Ergonomic basic divisions
- Flexible use in all common drawer and cupboard types
- Large range width
- Made of durable plastic
- Optionally available with wooden accessories



## SKT 400

SKT 400	H	W min.	W max.	D min.	D max.
K0 300	52	185	230	360	425
K0 400	52	285	330	360	425
K0 450	52	335	380	360	425
K0 500	52	385	430	360	425
K0 600	52	485	530	360	425
K0 800	52	685	730	360	425
K0 900	52	785	830	360	425
K0 1000	52	885	930	360	425
K0 1200	52	1085	1130	360	425

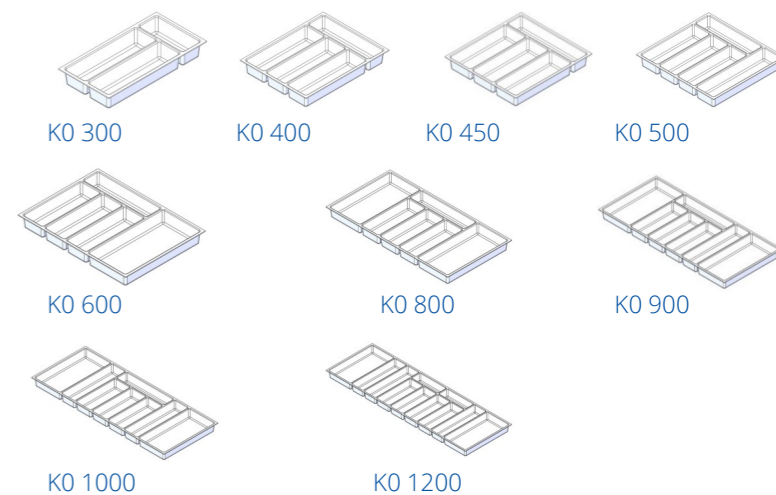

## SKT 500

SKT 500	H	W min.	W max.	D min.	D max.
K0 300	52	185	230	460	525
K0 375	52	260	330	460	525
K0 400	52	285	330	460	525
K0 425	52	310	390	460	525
K0 450	52	335	390	460	525
K0 475	52	360	430	460	525
K0 500	52	385	430	460	525
K0 575	52	460	530	460	525
K0 600	39,4 / 52	485	530	460	525
K0 800	39,4 / 52	685	740	460	525
K0 900	39,4 / 52	785	830	460	525
K0 1000	39,4 / 52	885	930	460	525
K0 1200	52	1085	1130	460	525

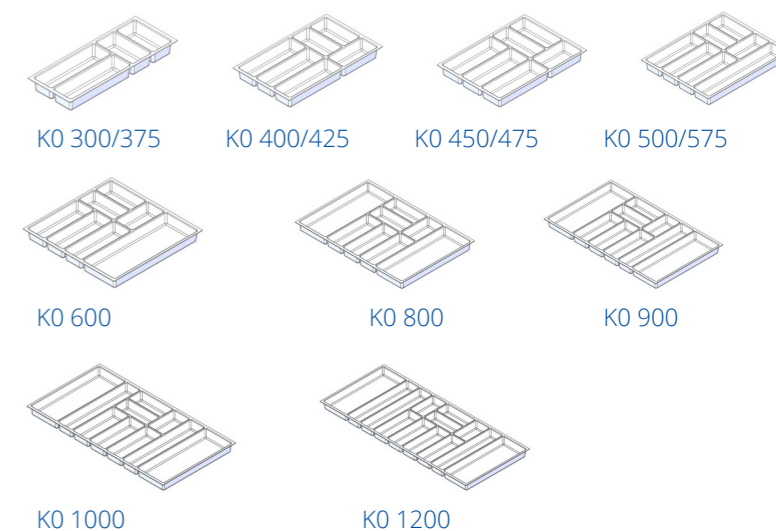

## SKT 600

SKT 600	H	W min.	W max.	D min.	D max.
K0 450	52	335	390	610	650
K0 500	52	385	430	610	650
K0 600	52	485	530	610	650
K0 800	52	685	730	610	650
K0 900	52	785	830	610	650
K0 1000	52	885	930	610	650
K0 1200	52	1085	1130	610	650

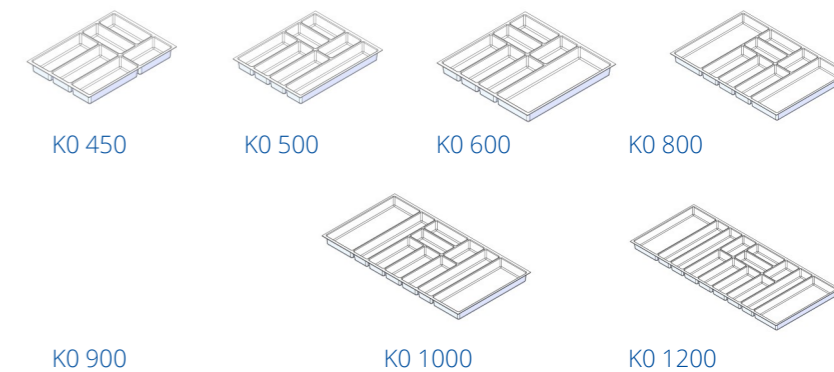

## Accessories

Accessories	H	W min.	D min.
Knife block	40	161	437
Film dispenser	40	161	437
Spice stairs	40	161	437
Spice tray	32	166	441





FLEXLINE is haptically appealing and visually eye-catching due to its selected materiality and slightly structured surface. It appears very filigree due to its low racks. Its clear lines integrate it into a high-quality, yet rather restrained look in the interior design. The MAGIC PEARL anti-slip mat forms the basis of a visually uniform drawer fitting with its elegant matt effect. At the same time, it gives the elements a necessary grip to prevent them from slipping.

The elements are refined by a light, all-round eroded structure and have a satin finish. The logical arrangement of the compartments allows for sensible storage of cutlery and other accessories. A multifunctional compartment can optionally accommodate spice inserts. The laterally closed design of the inserts allows free horizontal positioning and thus creates additional storage space for larger utensils or also the available accessories such as knife block, foil holder and spice inserts.

- Maximum design scope with only two elements
- Optimum use of the drawer in the kitchen cupboard
- Combination with an anti-slip mat makes additional storage space usable
- Frame insert small with 176 mm width, frame insert large with 276 mm width
- Use in standard up to 550 NT
- Single, double, triple drawer assignment possible
- Ergonomic basic divisions
- Flexible use in all standard drawer and cupboard types
- Made of resistant plastic
- Optional wooden accessories



## SKT 450 - 550

SKT 450 - 550	H	W min.	W max.	D min.	D max.
K0 300	50	176	176	363	523
K0 400	50	176	176	363	523
K0 450	50	176	276	363	523
K0 500	50	176	276	363	523
K0 550	50	176	276	363	523
K0 600	50	176	276	363	523
K0 700	50	176	276	363	523
K0 800	50	176	276	363	523
K0 900	50	176	276	363	523
K0 1000	50	2 x 176	1 x 276	363	523
K0 1200	50	1 x 176	2 x 276	363	523

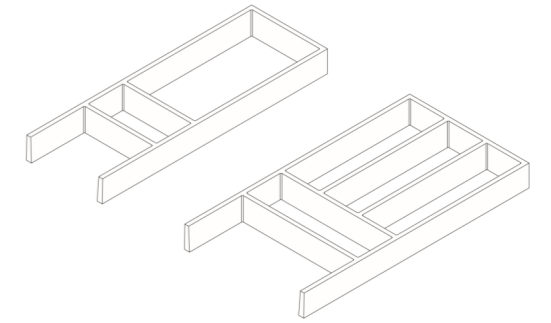

## Accessoires

Accessories	H	W min.	D min.
Spice stairs small	40	157	283
Spice tray small	40	157	283
Anti-slip mat	300	1200	363
Knife block	37/40	150/161	437/472
Foil holder	40/60	150/161	437/472
Spice rack	32/40	150/161	437/472
Spice tray	32	166	441
Position frame	54	180	473

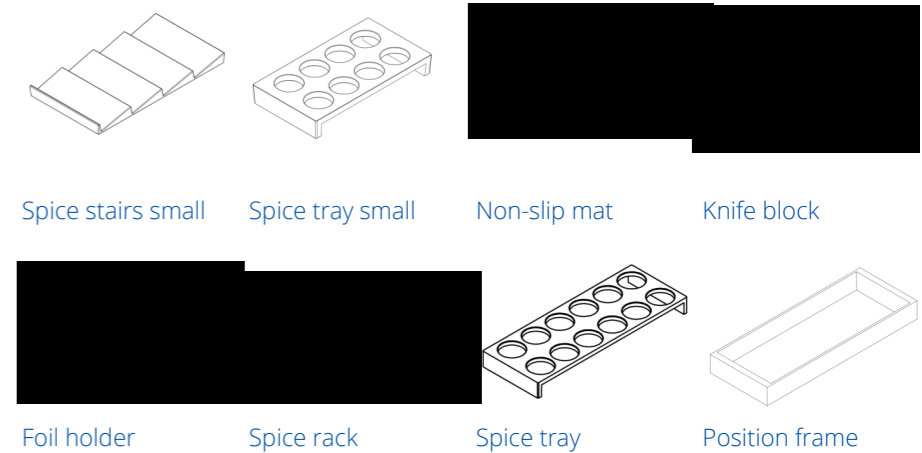

## Examples

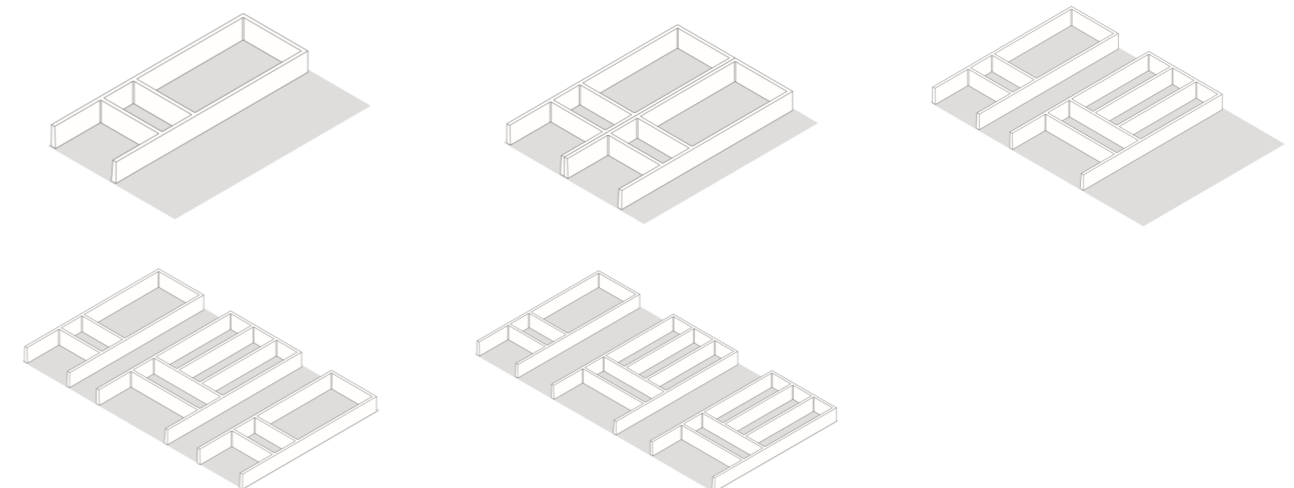

K0 1000

K0 1200

# FLEXYTRAY CLASSIC



Modern and user-oriented storage of cutlery and other kitchen accessories provides space for individual compartment divisions. Whether a small or large household, there is always a suitable compartment size as well as a longitudinal and transverse basic division. Furthermore, the FLEXYTRAY CLASSIC impresses with its linear structure but also its pleasing radii that give it a light touch.

The resistant plastic with a high-gloss or grained surface offers very good security in daily use. The FLEXYTRAY CLASSIC series can be individually adapted to any frame system on the market and is reliably supplied as a completely finished product.

- Optimum use of the drawer in the kitchen cabinet
- Available in all standard formats
- Easy to clean radii
- Variable vertical and horizontal space separation
- Flexible use in all common drawer and cabinet types
- Large range width
- Made of durable plastic



## SKT 400

SKT 500	H	W min.	W max.	D min.	D max.
K0 300	56	205	240	360	390
K0 400	56	305	340	360	390
K0 450	56	355	390	360	390
K0 500	56	405	440	360	390
K0 600	56	505	540	360	390
K0 600	40,4	485	530	360	380
K0 800	56	705	750	360	420
K0 800	40,4	685	730	360	380
K0 900	56	805	850	360	420
K0 900	40,4	785	830	360	380
K0 1000	56	905	921	360	420
K0 1000	40,4	885	930	360	380
K0 1200	56	1105	1150	360	420
K0 1200	40,4	1085	1130	360	380

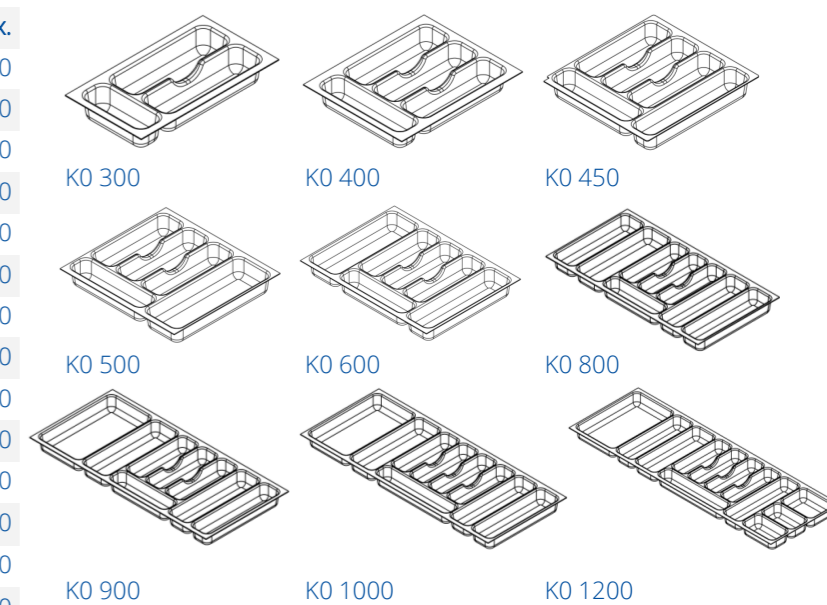

## SKT 500

SKT 500	H	W min.	W max.	D min.	D max.
K0 300	56	205	240	460	530
K0 400	56	305	340	460	530
K0 450	56	355	390	460	530
K0 500	56	405	440	460	530
K0 550	56	405	440	460	530
K0 600	56	505	540	460	530
K0 600	40,4	485	530	460	480
K0 800	56	705	750	460	520
K0 800	40,4	685	730	460	480
K0 900	56	805	850	460	520
K0 900	40,4	785	830	460	480
K0 1000	56	905	921	460	520
K0 1000	40,4	885	930	460	480
K0 1200	56	1105	1150	460	520
K0 1200	40,4	1085	1130	460	480

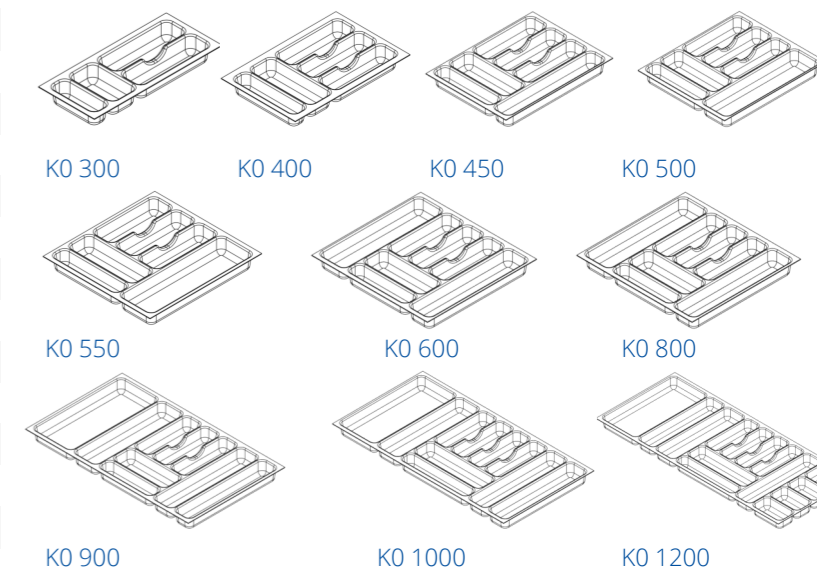

## Accessories

Accessories	H	L
Divider	45	95
Divider Knife	45	95

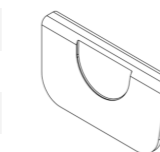

Divider

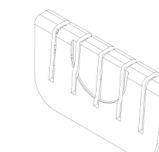

Divider Knife



## Spice tray

SKT 500	H	W min.	W max.	D min.	D max.
K0 400	40	285	330	460	530
K0 450	40	335	380	460	530
K0 500	40	385	430	460	530
K0 600	40	485	530	460	530

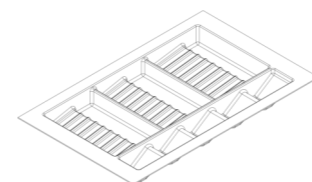

K0 400

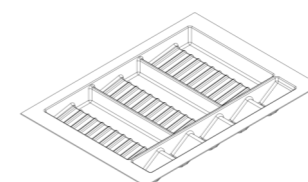

K0 450

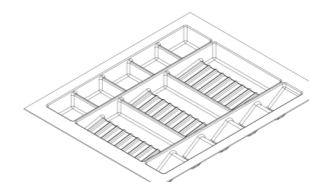

K0 500

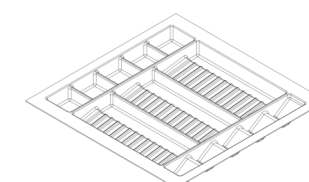

K0 600

Overview is the motto. With the spice tray from ELCO everything is kept on track. The classic, which has a straight-lined compartment layout, offers space for all standard spice containers. Thanks to the compartments on the sides, there is not only room for classic spice jars, but also for refill bags, which are well sorted in the SPICY spice tray. The spice tray is available from K0 400 - K0 600. The resistant plastic with a modern structured surface withstands daily use without restriction.



- Ideal arrangement of spices and refill bags
- Easy to clean
- Ergonomic basic divisions
- Made of resistant plastic



# SPRING



## Drawer insert

SPRING	Article no.	H	W min.	W max.	D min.	D max.
K0 600	S600	60/76	495	530	320	380
K0 600 - 1.200	Sides closed S600	60/76	548	any	320	380

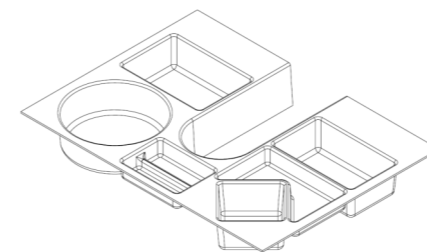

S600

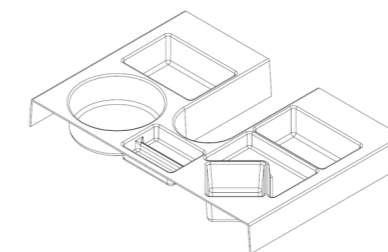

S600 plus

## Accessories

Accessories		H	Ø	W	D
3/4 bowl	DVK	30/37	191	-	-
Box high	HS	123	-	108	108
Flat case	TS	58	-	164	99

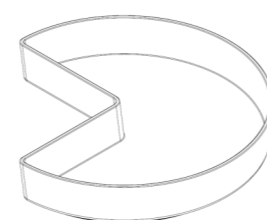

DVK

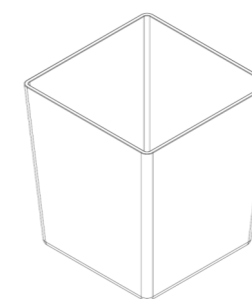

HS

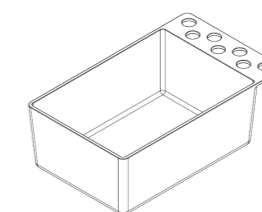

TS

The SPRING bath insert is a little all-rounder. Easy to handle and flexible to use. Its closed side view allows independent use in bathroom pull-outs from a cabinet width of 60 cm. With the use of an anti-slip mat, the free space created in larger cabinet widths can be used flexibly for other accessories. The SPRING bath insert can flexibly meet different requirements for vanity units. Its deeper inner sides of the siphon cut-out simultaneously cover the cut edges of the notch of the drawer bottom. With just one item, additional dimensions can be individually fitted from 60 cm car-case width, as the sides are closed.

With an anti-slip mat, which is also included in the range, the free spaces can thus be used for e.g. larger utensils or even towels. A plus point of SPRING is the optimal equipment with compartments and a matching high-quality range of boxes and trays. So everything is at its place. The SPRING series can be individually adapted to the frame systems commonly used on the market and is reliably supplied as a completely finished product.



- Optimum use of the bathroom drawer
- Use of the "second level"
- Modern design, attention to the detail
- Efficient compartment division
- Enclosure of the siphon cut-out
- Optional accessories on boxes and trays
- Anti-slip mat for use of wider drawers
- Easy-to-clean radii
- Flexible use in all common drawer and cupboard types

# TOP SORT



The flexible organiser system for kitchen base cabinets is well sorted and well equipped. Thanks to the high variance, it can accommodate almost any type and size of packaging. Whether tins, boxes, bags or other forms of storage. TOP SORT gives everything its appropriate place and allows the user an overview of all the storage material at any time. In addition, a high-quality plus is a plastic insert for up to three metal cans as well as translucent plastic trays. They can be moved onto the main frames as a so-called second level.

Another advantage is the ease of care. Not only are the trays from the accessories range easy to clean, but the insert itself is also easy to wipe out due to its material, surface and radii. This keeps the base unit hygienic at all times and also protects the carcass, even if liquids leak out. The hard-wearing plastic with a modern structured surface withstands a daily use without restriction. The TOP SORT series can be individually adapted to all frame systems commonly available on the market for cabinet widths from 600 to 1,200 mm and is reliably supplied as a completely finished product.

- Optimum and hygienic use of the base unit pull-out in the kitchen cabinet
- Basic insert for 60 to 120 mm corpuses
- Ergonomic basic dividers
- Accessories consisting of bowls and can inserts
- Easy-to-clean radii
- Flexible use in all common drawer and cupboard types
- Made of resistant plastic



## SKT 500

SKT 500	H	W min.	W max.	D min.	D max.
K0 600	100	494	560	461	540
K0 800	100	694	760	461	540
K0 900	100	794	860	461	540
K0 1000	100	894	960	461	540
K0 1200	100	1094	1160	461	540

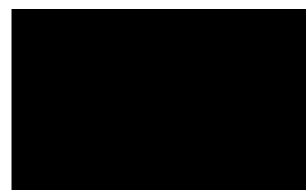

K0 600

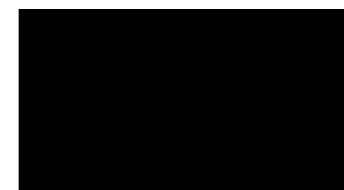

K0 800

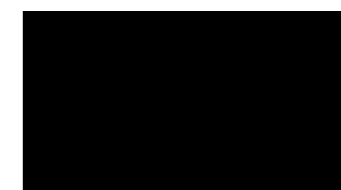

K0 900

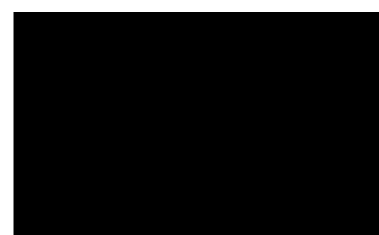

K0 1000

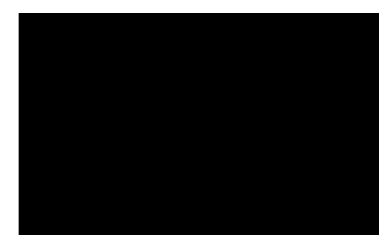

K0 1200

## Accessories

Accessories	H	W min.	D min.
3-part insert			
BergHOFF Can			
Organiser tray	70	223	149

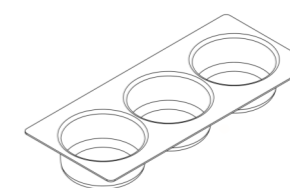

3-part insert



BergHOFF Can

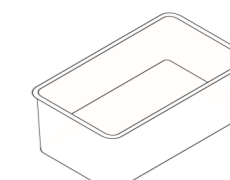

Organiser tray

## Combination examples

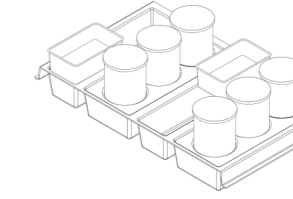
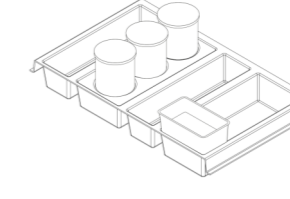
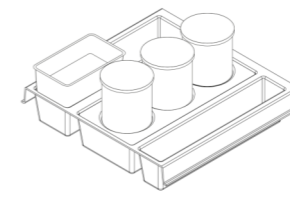
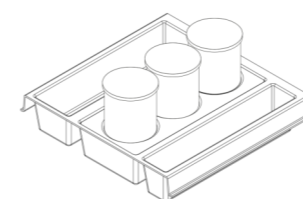



VISIO will shape the design of the next few years, as it is based on the designs of the latest generations of drawers. The compartments are arranged logically and ergonomically to meet all the requirements of contemporary use and can be further subdivided by means of separate compartment dividers. The VISIO (an extra-flat version) was developed especially for use under induction hobs.

With its low height, it ensures optimum use of space and thus economical household management. The resistant plastic with a modern structured surface withstands daily use without restriction. The VISIO series can be individually adapted to any frame system commonly used in the market and is reliably supplied accordingly as a completely finished product.



- Optimum use of the drawer in the kitchen cabinet
- Special version for use under the induction cooker
- Available in all standard formats
- Easy to clean radii
- Ergonomic basic divisions
- Variable vertical space division
- Flexible use in all common drawer and cabinet types
- Large range width
- Made of durable plastic

### SKT 400

SKT 400	H	W min.	W max.	D min.	D max.
K0 300	52	185	230	360	430
K0 400	52	285	330	360	430
K0 450	52	335	380	360	430
K0 500	52	385	430	360	430
K0 600	52	485	530	360	430
K0 800	52	685	730	360	430
K0 900	52	785	830	360	430
K0 1000	52	885	930	360	430
K0 1200	52	1085	1130	360	430



### SKT 500

SKT 500	H	W min.	W max.	D min.	D max.
K0 300	52	185	230	460	530
K0 400	52	285	330	460	530
K0 450	52	335	380	460	530
K0 500	52	385	430	460	530
K0 600	54/40	485	530	460	530
K0 700	52	585	630	460	530
K0 800	52/40	685	730	460	530
K0 900	52/40	785	830	460	530
K0 1000	52/40	885	930	460	530
K0 1200	52/40	1085	1130	460	530

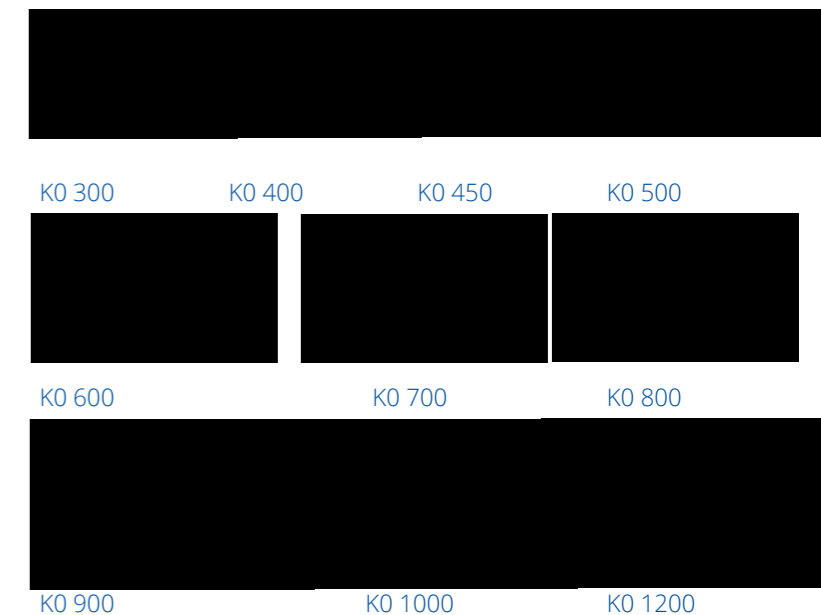

### Accessories

Accessories	H	L
Divider	50	90
Divider Knife	50	90

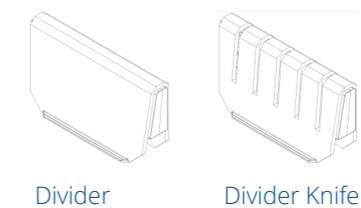

# WATCH



Especially in the bathroom, there is a need to store different cosmetics and accessories for daily use. If several people or even generations live in one household, well-sorted access to the articles should be ensured, i.e. everything should be in perfect order. In addition, the wellness trend calls for new design approaches. WATCH completely fills the drawers and pull-outs, leaving no room for untidiness. The programme also offers the option of elegantly concealing recesses for the siphon. The programme sets itself apart from other products with two decisive advantages.

In addition to its well thought-out basic layout, it offers maximum flexibility and modernity thanks to an optionally available assortment of coloured boxes and trays. Furthermore, the attachment of a three-quarter tray uses the so-called second level and thus the otherwise unused space of a drawer. The WATCH series can be individually adapted to the drawer systems commonly used on the market and is reliably supplied as a completely finished product.



- Full use of the bathroom drawer
- Use of the second level
- Modern design, attention to detail
- Interesting compartment division
- Edging of the siphon cut-out
- Optional accessories on boxes and trays
- Easy to clean radii
- Flexible use in all common drawer and cabinet types

## Drawers

WATCH	H	W min.	W max.	D min.	D max.
W600	60	490	530	320	380
W800	60	680	730	370	380
W900	60	780	830	370	420
W1000	60	880	930	370	420

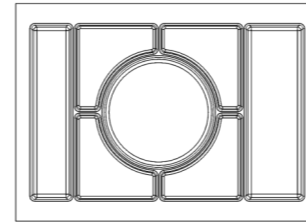

W600

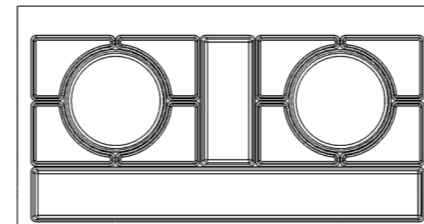

W900

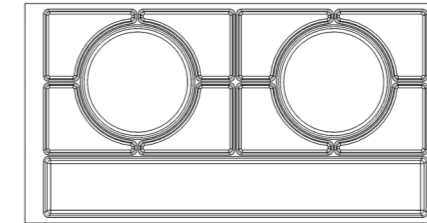

W800

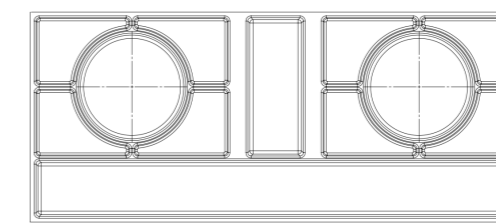

W1000

## Accessories

Accessories	H	Ø	W	D
3/4 Case	59,5/64,5	218	-	-
Box high	123	-	108	108
Case flat	58	-	164	99

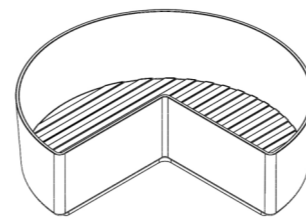

Case

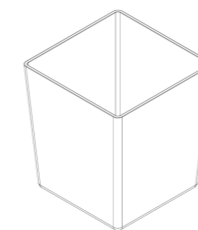

Box high

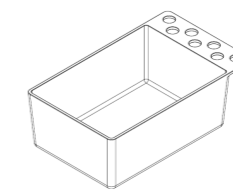

Case flat



WINGS	H	W	D
Set	25	151	320 - 380

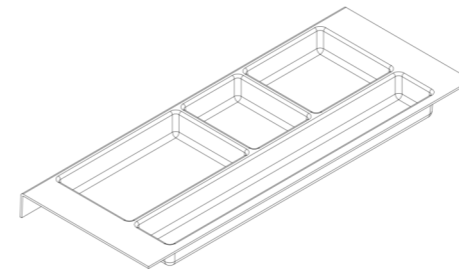

WINGS Part 1

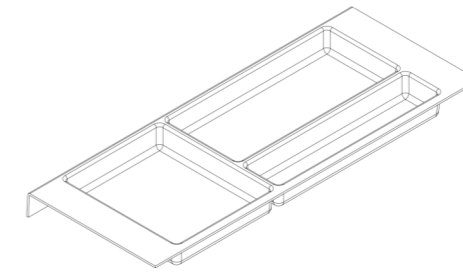

WINGS Part 2

With its WINGS insert system, ELCO has developed a product that can be used in many ways. Practical in use with logically arranged compartments, WINGS is not only conceivable in the kitchen or bathroom cupboard, but also in the office, dressing room or wardrobe. The hard-wearing plastic with a modern structured surface withstands daily use without restriction.

All cabinet sizes can be equipped with just two basic items. The one-sided closed design of the inserts allows free horizontal positioning. In combination with an anti-slip mat, additional storage space is created.



- Optimal use of the drawer in the kitchen or bathroom cabinet
- Easy to clean
- Ergonomic basic divisions
- Flexible use in all common drawer and cupboard types
- All cabinet sizes can be equipped with two articles
- Made of durable plastic
- Combination with an anti-slip mat makes additional storage space available

# ELCO Drawers

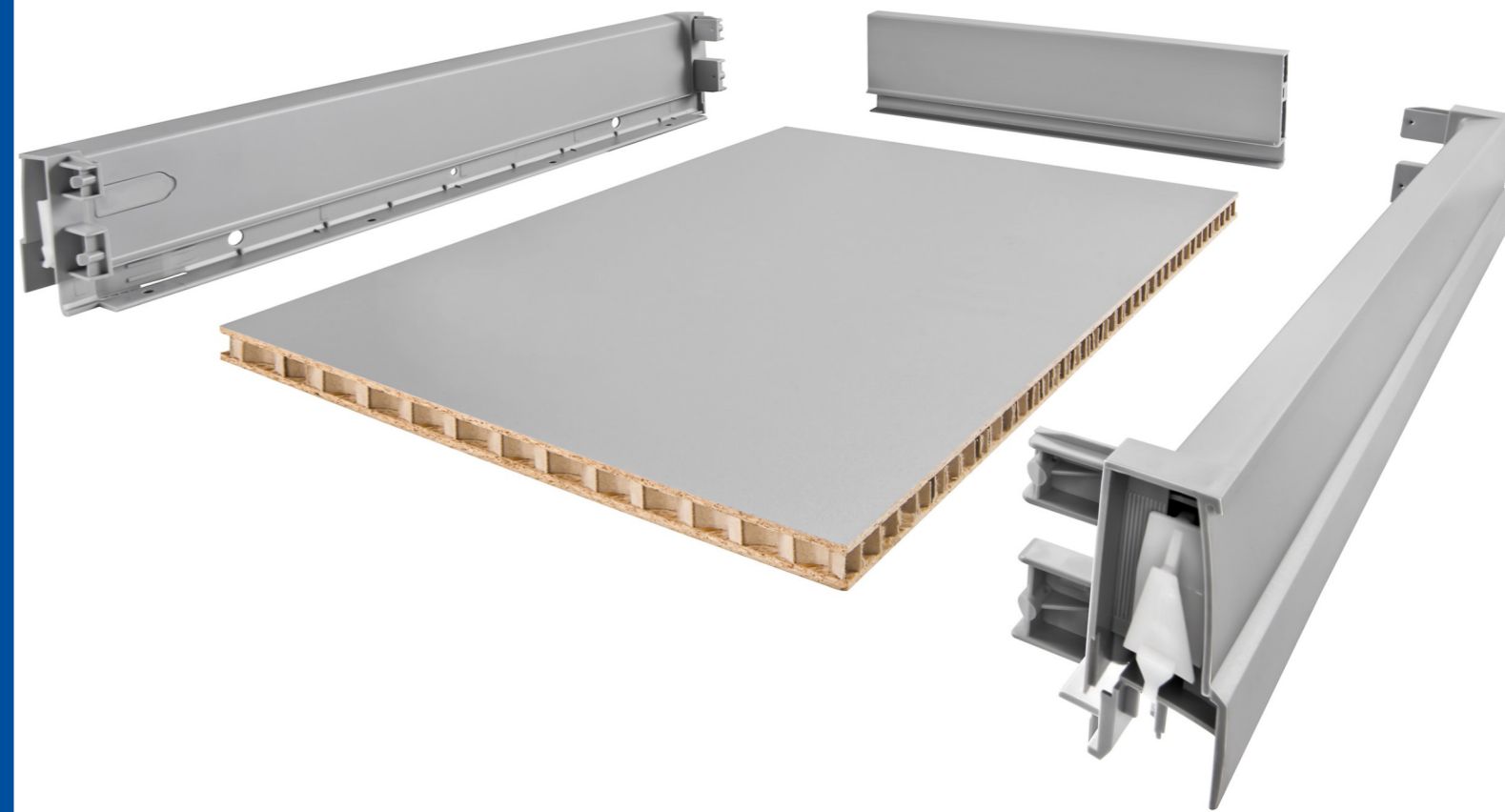



Based on many years of experience in drawer production, the SINUS system was developed as a modular concept. The development focused on attractive design, high durability and stability as well as absolute ease of assembly. The result is a versatile drawer system which, in addition to the problem-free use, also offers a wide range of design options.

The pages can be designed in almost unlimited ways and lend themselves to a consistent corporate design. The standard colours are F174 = pure white (similar to RAL 9010) and F120 = light grey (similar to RAL 7040).

- Front fitting system is specially developed and patented for SINUS
- Fast and tool-free assembly/disassembly
- Easy mounting of knobs and handles
- Adjustment also takes place without tools
- Sides are plugged together and lock securely in place
- Any width dimension can be produced
- Problem-free logistics due to modular system design
- Durable, long-lasting polystyrene
- Certified quality by LGA test, quality certificate no. 544 for drawers/no. 545 for pull-out shelves
- Can be combined with ELCO cutlery trays



## Individual parts

Side 4-sided, without groove for decorative strips	H	D
	90	430
	90	485
	90	485/2-level set
Special dimensions	on request	

Side 3-sided, without groove for decorative strips	H	D
	90	430
	90	485
	90	485/2-level set
Special dimensions	on request	

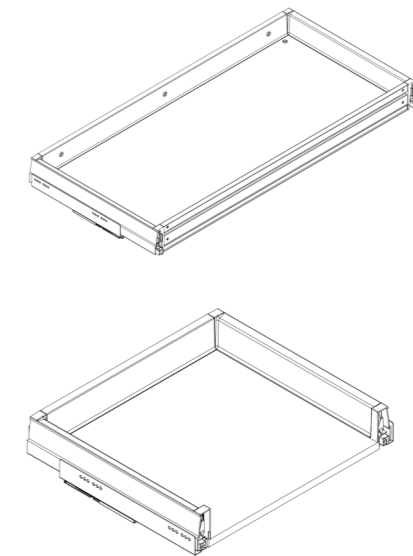

## Accessories

Wire side single, with adjustment	Ø	D
	8	430
	8	485

  

Front receptacle, L/R usable	Ø	
	8	Screw-on
	8	With dowels

Carcase width	Ø Wire back panel simple
30er	8
40er	8
45er	8
50er	8
60er	8

## Fitting dimensions

	Inner	A	B	C
K0 300	267	218	187,8	194
K0 350	317	268	237,8	244
K0 400	367	318	287,8	294
K0 450	417	368	337,8	344
K0 500	467	418	387,8	394
K0 600	567	518	487,8	494
K0 700	667	618	587,8	594
K0 800	767	718	687,8	694
K0 900	867	818	787,8	794
K0 1000	967	918	887,8	894

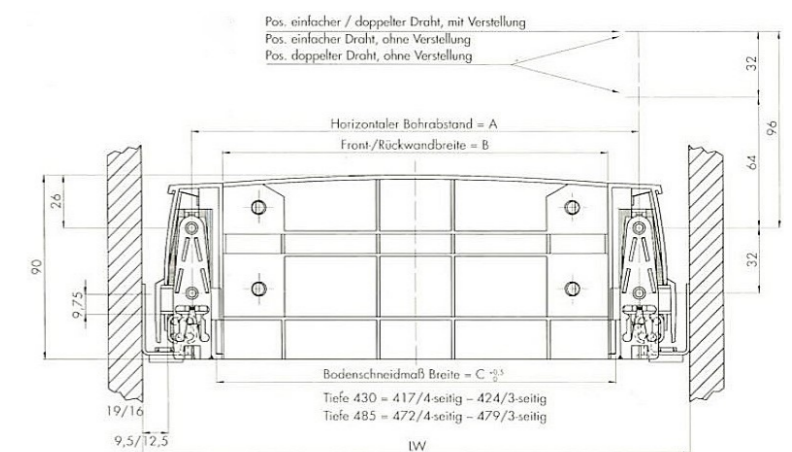

Sämtliche Artikelnummern gelten für die Ausführung für 16 mm Böden. Für andere Ausführungen gelten andere Artikelnummern. Technische Änderungen bleiben vorbehalten.



Folding frame SUPERKLICK - a drawer system that has proven itself millions of times over the years. Proof of quality and problem-free application. We have developed this product especially for KD furniture (furniture in a box) and have paid special attention to the durability of the connections and the easy assembly even for laymen. The simple assembly without additional aids allows the variation of the delivery forms and thus the possibility for an individual packaging. All profiles are extruded, so there are practically no restrictions when determining the width and depth dimensions. We supply the frame heights between 85 and 140 mm.

This makes SUPERKLICK the right drawer for almost any application. The extruded profiles and front connectors for 3-sided drawers are produced exclusively from high-impact polystyrene with antistatic finish. We produce the folding corner connectors from high-quality polypropylene in a special setting. Both materials are not only environmentally safe in production and processing, but can also be recycled without any problems. This makes SUPERKLICK the right drawer for furniture of all kinds, also in terms of the increasingly important protection of the environment.

- Connection of the corner and front joints with the profiles is done by simply plugging them together
- Different versions for drawer and front connections
- Clips (S020042) for drawers with excess width firmly connect drawer frame and base
- distance bush (J010679) for positive screw connection of front panel
- Colour white (F170)
- Can be combined with ELCO cutlery tray COMFORT
- Special versions and colours on request



## Three-sided

### Article no.

J61xxxx	EV <sup>1</sup> + FV <sup>2</sup> oder AP <sup>3</sup> lose
J62xxxx	EV mounted in the back wall, FV or AP lose
J65xxxx	EV + FV Mounted in the side panels
J71xxxx	EV mounted, FV or AP lose
J72xxxx	EV + FV mounted
J73xxxx	With base, fully assembled

- 1 Corner connectors
- 2 Front connectors
- 3 Screw-on plate

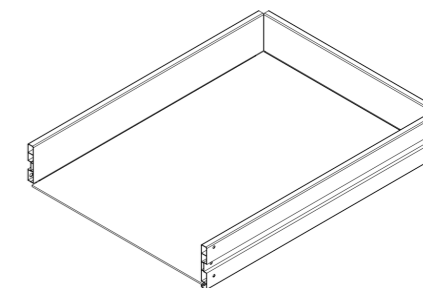

## Four-sided / Englischer Zug

### Article no.

Article no.		Four-sided/ Engl. Zug
J74xxxx	EV lose	Four-sided
J75xxxx	EV mounted in the front and rear wall	Four-sided
J76xxxx	EV mounted in the side panels	Four-sided
J78xxxx	EV mounted	Four-sided
J79xxxx	With base, fully assembled	Four-sided
J74xxxx	EV lose	Engl. Zug
J75xxxx	EV mounted in the front and rear wall	Engl. Zug
J76xxxx	EV mounted in the side panels	Engl. Zug
J78xxxx	EV mounted, front piece with glued in or snap-	Engl. Zug
J79xxxx	With base, fully assembled	Engl. Zug

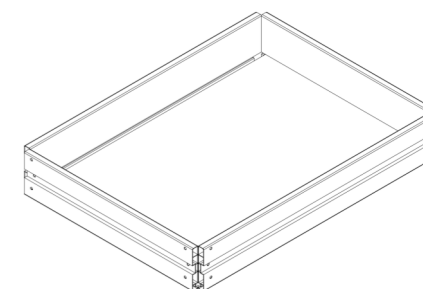

## Profile versions / Guide systems / Corner connectors

Profile versions	Frame height	Running groove
61080	85 mm	Lt. Profile cut
61140	140 mm	Lt. Profile cut

	Frame height	Frame height
Profile, Bottom groove 3 mm	J061080	J061140
Corner connector without Locking	LS J061071 RS J061072	LS J061157 RS J061158
Corner connector with internal locking	LS J061073 RS J061074	LS J061151 RS J061152
Corner connector with External locking	LS J061075 RS J061076	LS J061153 RS J061154
Front connector E2/E3 dowel	LS J061077 [1] RS J061078 [1]	LS J061155 [1] RS J061156 [1]
Screw-on plate, 3 mm strong	LS J061094 [4] RS J061095 [4]	LS J061159 [4] RS J061160 [4]





Stecksystem (Plug-in system) drawers for small series from 50 pieces per dimension in fixed dimensions - also available assembled on request. Made of highly impact-resistant polystyrene with antistatic finish. Polystyrene is environmentally friendly and easy to recycle. We offer various plastic and metal guide systems as well as cutlery inserts as accessories. Delivery forms: Unassembled (profiles cut to fixed dimensions - connecting elements loose for self-assembly).

Pre-assembled (profiles cut to fixed dimensions - connecting elements are fitted in the side panels. Side panels and back/front wall must be assembled by the end user). Fully assembled with floor (profiles cut to fixed dimensions - side panels, rear/front wall and hard-fibre floor are completely assembled as a unit). Other delivery forms are possible, please enquire.

- Standard colour: F170 = white
- Available versions, height: 43, 60, 85 mm
- Three-sided, four-sided (English pull)
- Profiles in stock lengths 3,500 mm with loose corner and front connectors

## 43 mm profile height

Version	Article no. (left, right)		Pcs./original	m
Profile	H050400		80 à 3.500 mm	280 m
Front connector C1	H050402	H050403		
Corner connector without locking	H050401			

## 60 mm profile height

Version	Article no. (left, right)		Pcs./original box	m
Profile	H050404		54 à 3.500 mm	189 m
Front connector E2	H050472	H050473	200	
Front connector C2 (special version)	H050406	H050407	200	
Corner connector without locking	H050405	H050520	200	
Corner connector with external locking	H050521	H050522	200	
Corner connector with internal locking	H050552	H050553	200	

## 85 mm profile height

Version	Article no. (left, right)		Pcs./original box	m
Profile	H050404		40 à 3.500 mm	140 m
Front connector E2	H050514	H050515	140	
Front connector C2 (special version)	H050434	H050435	140	
Corner connector without locking	H050523	H050524	140	
Corner connector with external locking	H050525	H050526	140	
Corner connector with internal locking for Englischer Zug	H050554	H050555	140	
Corner connector - running groove closed at the front	H050422	H050423	140	
Corner connector - running groove open at the front	H050420	H050421	140	



## Drawer

Product		H
Basic drawer	From 100 mm plinth height	NH 170
Basic drawer	From 150 mm plinth height	NH 220
Organisation drawer	with integrated plastic roller guide	NH 60
Fascia-lift fitting	with stabilisation crossbar	
Base foot	up to 230 mm	NH 100
Base foot	with fascia lift fitting up to 230 mm	NH 100

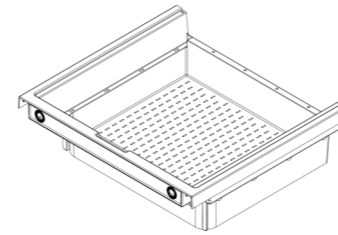

Basic drawer NH 170

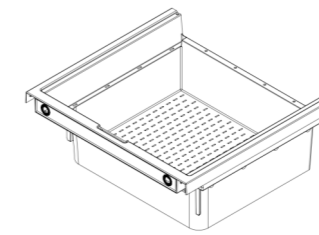

Basic drawer front NH 220

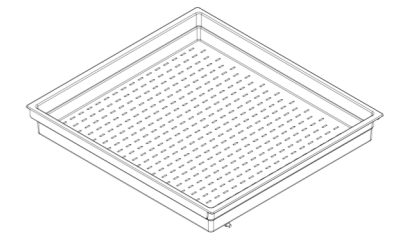

Organisation drawer NH 60

The built-in oven not only serves its purpose, but also has to serve as storage space for baking trays, grill grates and various other utensils, which have to be removed in a cumbersome manner before they can be put into operation. Conventional pedestal drawers offer only little relief. TOP VOLUME<sup>2</sup> offers an optimum overview thanks to an integrated organiser drawer. The TOP VOLUME<sup>2</sup> plinth drawer system puts an end to storage problems around the oven.

Making optimum use of the full plinth space, the system offers precise space for all oven utensils at a height of 17 cm or 22 cm. Baking trays and grids can be stored in a special Orga drawer integrated into the drawer. When the plinth drawer is open, it can simply be moved backwards to reveal the generous storage space underneath: finally, room for cake tins or other utensils. A specially developed panel lift mechanism prevents the plinth panel from dragging on the floor covering when the drawer is pulled out.

- Large-volume storage space
- Additional storage possibilities due to sliding Orga drawer
- Easy to assemble construction
- Anti-slip floor structure
- Optimum adjustability of the plinth panel
- Low storage space requirement
- For all oven cabinets with a plinth height of 100 mm or more





TOP KÄSTEN - the top product among ELCO plastic drawers - in proven quality. The system is characterised by the straight-lined design and modern surfaces, as well as optimised technology and advantages in use. The compact and solid construction with the mounted and welded-in adapters ensures maximum stability and torsional rigidity. With wall thicknesses that meet the high demands of increasing quality awareness. Even more beautiful with decorative skirts and even more individual with optimal accessories. We supply our high-quality, one-piece injection-moulded cutlery inserts to match our TOP crates series.

Also available as a 2-level set: Two cutlery levels ensure space-saving storage of cutlery. By pushing back the upper insert, access to the lower level is possible. Multi-purpose trays complement the extensive range of cutlery inserts and make the TOP CHEST even more functional overall. All drawers as well as the listed accessories are available in the standard colours F174 - pure white (similar to RAL9010). The wire top frames are available in F340 - chrome-plated.

- Surface is made of easy-to-clean and highly impact-resistant polystyrene from BASF
- Proven front fitting system supplied millions of times over
- LGA quality certificate no. 437
- Integrated mounting flap allows knobs and handles to be attached to the front panel at a later date
- Drawer bottom thickness for 3000-42 VF and 48 VF in 8 mm, alternatively 3.2 mm



## 3000-48 Serie VF

K0	Article no.	B (external dimension) <sup>1</sup>	W/D (inside dimension) <sup>2</sup>	Full plastic cover	Cutlery tray CLASSIC
275	M148230	225	181/450	M161127	L053479
300	M148260	250	206/450	M161130	L053480
400	M148360	350	306/450	M161140	L053481
450	M148410	400	356/450	M161145	L053482
500	M148460	450	406/450	M161150	L053483
550	M148510	500	456/450	M161155	L053484
600	M148560	550	506/450	M161160	L053485

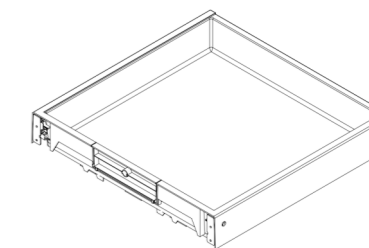

Example: K0 500, 3000-48 Serie VF

## 3000-48 2-level set

K0	Article no.	B (external dimension)	B/T (inside dimension)	Full plastic cover	Cutlery tray CLASSIC
450	M148418	400	-	M161145	eingebaut
500	M148468	450	-	M161150	eingebaut
600	M148568	550	-	M161160	eingebaut

## 3000-42 Serie VF

K0	Article no.	B (external dimension)	B/T (inside dimension)	Full plastic cover	Cutlery tray CLASSIC
300	M142260	250	206/396	M161130	L053420
400	M142360	350	306/396	M161140	L053421
450	M142410	400	356/396	M161145	L053422
500	M142460	450	406/396	M161150	L053423
600	M142560	550	506/396	M161160	L053425

## Top frame for 3000-42

For drawer	3-sided Item no.	Cross divider Item no.
M142260/1	M162030	P116204
M142360/1	M162040	P116304
M142410/1	M162045	P116354
M142460/1	M162050	P116404
M142560/1	M162060	P116504

Note: It is also possible to obtain wire frames for the TOP drawers.

<sup>1</sup> Outer dimensions apply without decorative aprons. If the decorative aprons are used, the external dimensions increase by 4 mm.  
<sup>2</sup> Internal dimensions are determined 50 mm above the floor and are also the external dimensions of the cutlery inserts.

## 3000-HU (Cooker under-cabinet)

K0	Article no.	B (outside dimension)	W/D (inside dimension)	H	Cutlery tray CLASSIC
600	M142570	550	506/396	72	L053425

## Top frame for 3000-48

For drawer	3-sided Item no.	Cross divider Item no.
M148260/1	M162130	P116204
M148360/1	M162140	P116304
M148410/1	M162145	P116354
M148460/1	M162150	P116404
M148510/1	M162155	P116454
M148560/1	M162160	P116504

## Floor clips

Article no.	Thickness	For
M161021	8	Chipboard
M161022 (front)	3,2	Hardboard
M161023 (back)		

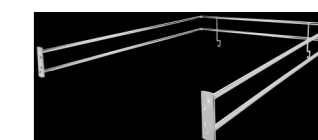



The product group 3000-BZ has been developed as an independent system within the TOP KÄSTEN series 3000. The design has been revised and improved without losing the visual connection to the TOP BOX series. Tried and tested features such as the assembly flaps have been adopted, while new features have been added. The modified design of the sides with the decoration clips is the outstanding feature of the series.

The front panels are fitted using the same front fittings and screw-on positions as for the other drawers in the TOP KÄSTEN series. Decorative clips to cover the screw holes on the sides are included in the standard scope of delivery for the 3000-BZ group. The clips are supplied loose and simply clipped into the holes.

## 3000-BZ

Article no.	Carcase width	W/D (external dimension)	W/D (inside dimension)	Wire-top frame
M127260	300	250/275	206/240	M 162 430
M127310	350	300/275	256/240	M 162 435
M127360	400	350/275	306/240	M 162 440
M127410	450	400/275	356/240	M 162 445

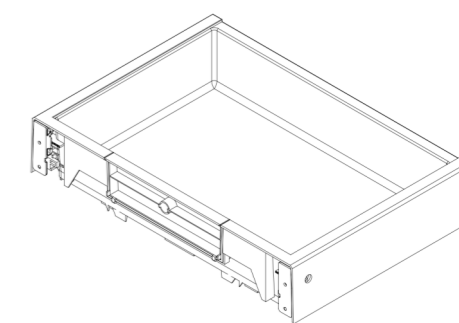

Example: KO 400

## Colours

Drawers	Wire and stacking frames	Insert tray	Top shell
F174 - Pure white (similar to RAL9010)	F340 - Chrome plated	F174 - Pure white (similar to RAL9010)	F174 - Pure white (similar to RAL9010)

## Accessoires

Article no.	Accessories
M127100	Insert 150 mm wide
M127101	Insert 100 mm wide
M127102	Top shell
M161025	Decoration Clips (Triangle)
M161016	Decoration Clips (Square)

Note: It is also possible to obtain wire frames for the TOP drawers.

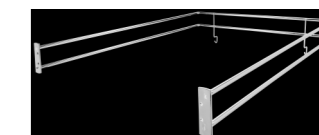

# PLASTIC GUIDES



Guide rails for connecting, without locking



Guide rails to screw on, without locking

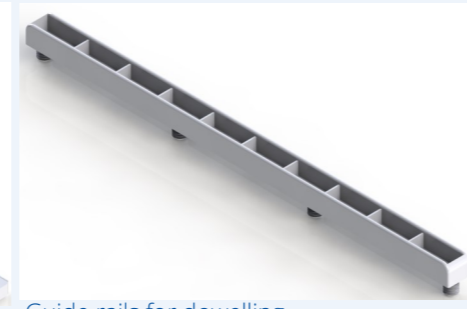

Guide rails for dowelling, without locking



Guide rails for connecting, with locking device

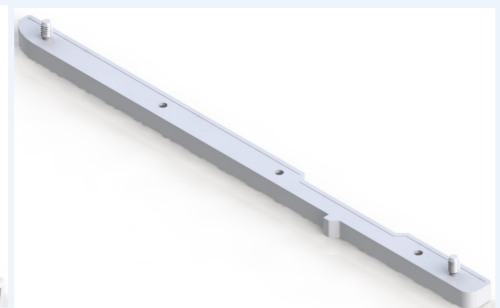

Guide rails to the dowel, with locking device



Roller guides

Guide rails for drawers are important functional elements in furniture construction. We are specialists in these articles. Many years of experience, a wealth of ideas, advanced technology and the use of high-quality raw materials are the basis for the quality of our products and our market position. The mature and market-recognised programme enables us to produce large series, which is why we deliver from stock at short notice and offer favourable prices.

Our guide rails are not only ideally suited for our entire drawer systems, but also for third-party products. This data sheet shows the latest status of our plastic guide systems product group. We are constantly developing further in order to be able to offer the market ever new and better problem solutions.



R050184, System guide rail

- Guides with and without locking device
- Internal or external locking prevents the drawer from falling out when pulled out
- All locking and rolling slides are supplied as a set (left/right)

## CONNECTING without locking

Article no.	L	H	D
R050726	280	16	6
R050197	280	16	8
R050708	280	16	9
R050198	280	16	10
R050709	280	16	12,5
R050724	280	16	13,4
R050710	280	16	14,4
R050711	280	16	16
R050725	280	16	18,6
R050199	280	11	20

## DOWEL without locking

Article no.	L	H	D
R050165	285	16	8
R050749	340	16	8
R050701	300	16	10
R050753	300	16	13,4
R050873	300	16	16
R050702	300	10	20

## DOWEL with locking

Article no.	L	H	D
R050842	255	13,7	8
R050752	285	13,7	8
R050792	285	13	8
R050836	375	13	8
R050764	285	13,7	10
R050722	285	13,7	13,4
R050882	285	13	16
R050788	375	13	22

## Guide Rails

Article no.	Description
R050184	System guide rails, plus system bracket R010094
R050163 / R050715 / R050716	Wire basket guide rails, (X/Y) = (total height/utility): R050163 (26/16), R050715 (24/14), R050716 (18/8)
R050767	Guide rails for screwing underneath without and with locking device R010958

## TIGHTENING without locking

Article no.	L	H	D
R050164	285	16	8
R050863	368	16	8
R050176	450	16	8
R050190	270	16	9
R050864	368	16	9
R050166	350	16	16
R050167	350	16	24

## CONNECTING with locking

Article no.	L	H	D
R050748	255	13,7	8
R050738	285	13,7	8
R050744	285	13,7	10
R050852	340	13,7	10
R050774	375	13	12
R050874	285	13	16
R050739	Drawer stoppers for third-party manufactures		

## ROLLING GUIDES

Article no.	Description	with/without Locking
R050707	With riveted plastic Roller R050189	Without locking
R050703	With loosely attached plastic castor R050189	With external locking
R050192	Spacer strip for dimension increase of article R050703	-
R050704	Special screw 4.0x25 mm for Article R050703	-
R050705	Special screw 4.0x33 mm for article R050703 in connection with spacer with spacer strip R050192	-

ELCO Waste bin



# CASE SELECT



## Recyclables separation system

Bin	Article no.	H	W	D	Colour
5,2 Litres	10239157	220	160	220	light grey
5,2 Litres	10239311	220	160	220	quartz grey
8 Litres	10230157	350	160	220	light grey
8 Litres	10230311	350	160	220	quartz grey
11,7 Litres	10238157	220	221	320	light grey
11,7 Litres	10238311	220	221	320	quartz grey
18 Litres	10231157	350	221	320	light grey
18 Litres	10231311	350	221	320	quartz grey

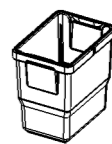

5,2 Liter

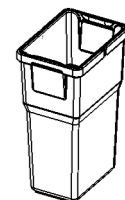

8 Liter

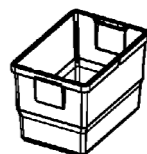

11,7 Liter

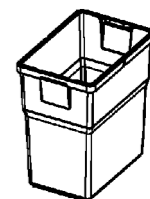

18 Liter

## Accessories

Lid	Article no.	Colour
5,2 / 8 Litres	10246271	light grey
5,2 / 8 Litres	10246869	quartz grey
11,7 / 18 Litres	10247271	light grey
11,7 / 18 Litres	10247869	quartz grey

5,2 / 8 Litres

11,7 / 18 Litres

Accessories	B (corpus width)
System coverage	300 - 1200
Non-slip mat	300 - 1200

System coverage

Non-slip mat

A well thought-out and contemporary recyclables separation system is characterised by flexible and safe handling as well as easy-care design. The ELCO CASE SELECT recyclables separation system offers common volumes and dimensions for all requirements in modern kitchen base units. They are configured in pull-outs to give the user the greatest possible benefit, whatever the requirements in terms of lifestyle or regional conditions.

The high-quality, injection-moulded bins are equipped with sturdy carrying handles that also hold the bin liner in place. Depending on requirements, single, double, triple or multiple separations are possible, and an optionally available anti-slip mat prevents the bins from slipping.

- Optimum use of the storage space in the base cabinet
- Standard market volumes from 5 litres to 18 litres
- Coordinated width and depth grid
- Made of resistant plastic using injection moulding process
- Easy to clean bins
- Bin liners can be fixed with handles
- Lid / system cover closes the waste separation system at the top
- Optional anti-slip mat provides additional stability
- Bins can be used individually or in combination
- Colour options: quartz grey and light grey



## Examples

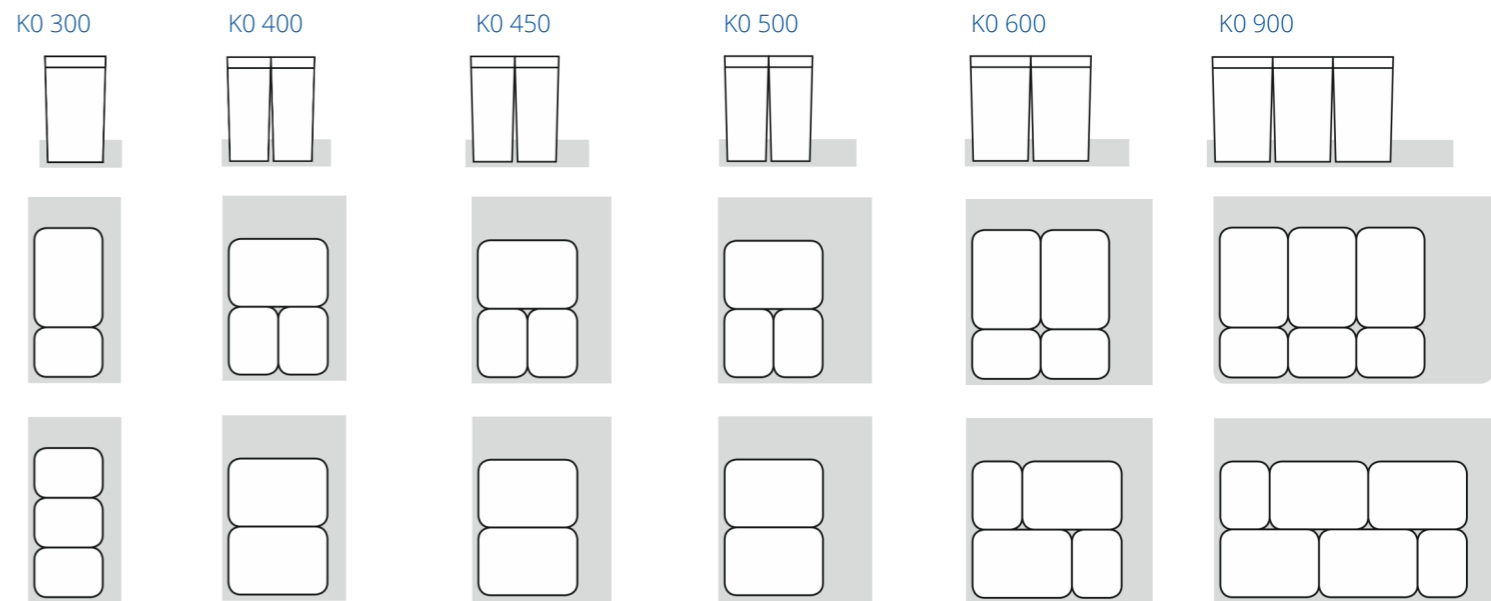

# CASE SELECT LEVEL



A well thought-out and contemporary recyclables separation system is characterised by flexible and safe handling as well as an easy-care surface. CASE SELECT LEVEL offers common volumes and dimensions for all requirements in kitchen base units and is easy to retrofit. CASE SELECT LEVEL is a suspended recyclables separation system on a full-extension runner with universal storage compartment.



- Optimum use of the storage space in the base cabinet
- Standard market volumes from 5 litres to 18 litres
- Easy to clean bins and frames
- Waste bags can be fixed with handles
- Lid / cover frame closes the waste separation area at the top
- Easy to retrofit, quick assembly
- Additional storage compartment e.g. for bin liners
- Colour versions: quartz grey and light grey, other colours on request

## Hanging frames

Hanging frames	
Variation 1	Full-extension runner for 2x waste bins 18 litres
Variation 2	Full-extension runner for 2x waste bin 8 litres and 1x waste bin 18 litres
Further variations	on request



Variation 1



Variation 2

## Recyclables separation system

Litter bin	Article no.	H	W	D	Colour
5,2 Litres	10239157	220	160	220	light grey
5,2 Litres	10239311	220	160	220	quartz grey
8 Litres	10230157	350	220	light grey	
8 Litres	10230311	350	160	220	quartz grey
11,7 Litres	10238157	220	221	320	light grey
11,7 Litres	10238311	220	221	320	quartz grey
18 Litres	10231157	350	221	320	light grey
18 Litres	10231311	350	221	320	quartz grey

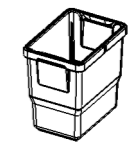

5,2 Liter

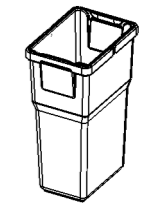

8 Liter

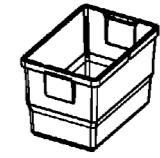

11,7 Liter

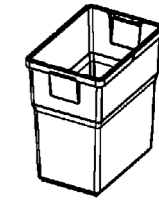

18 Liter

## Accessories

Lid	Article no.	Colour
5,2 / 8 Litres	10246271	light grey
5,2 / 8 Litres	10246869	quartz grey
11,7 / 18 Litres	10247271	light grey
11,7 / 18 Litres	10247869	quartz grey



5,2 / 8 Liter

11,7 / 18 Liter

Cover Frame	<b>B (carcase width)</b> 300 - 1200
-------------	--

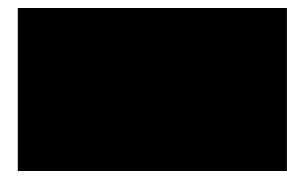

Cover Frame



# ELCO Non-sliding mats



# MAGIC PEARL

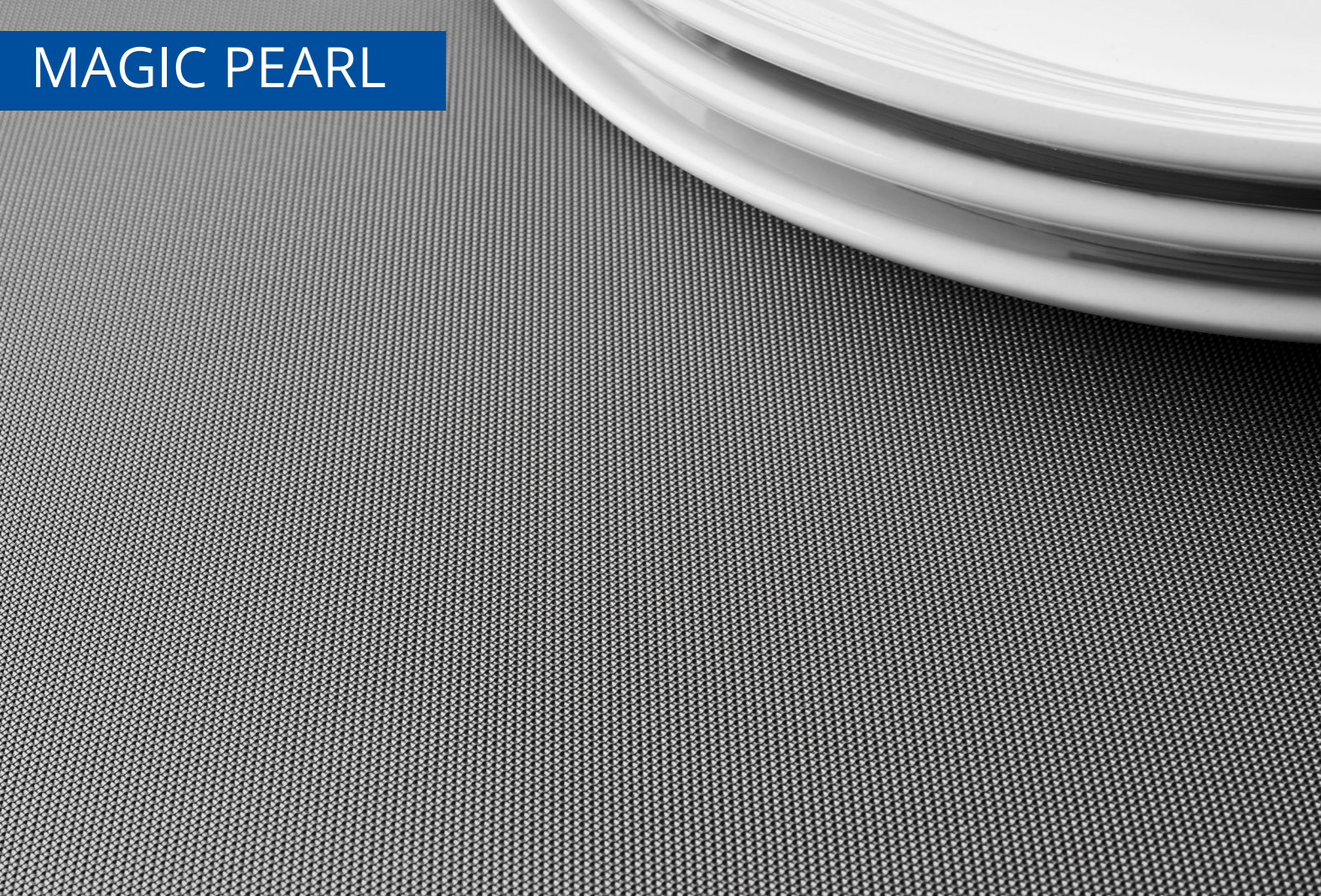

A visual and haptic experience is the anti-slip mat MAGIC PEARL with its innovative surface and fine pearl structure. Through an intelligent mix of technology and design, properties are made possible in the lower to medium price segment that are otherwise only reserved for the premium and luxury class. Even the first impression is a "wow effect". The fine pearl structure of this finish skillfully refracts the light on the elegant matt surface. When touching the products, the structure is an experience and one can immediately "grasp" the very valuable haptics.



The secret of these product properties is the double-layer structure of the mat material. A layer of higher-quality plastic, with a surface specially laser-engraved for this purpose, is refined on a basic carrier material. In combination, this not only protects the floor but also has an anti-slip effect. In combination with a cutlery insert with pearl surface, a homogeneous ensemble is created. The MAGIC PEARL series is available as sheet material in standard dimensions or as cut-to-size material for the frame systems commonly used in the market.

- Food-safe in accordance with the European Plastics Regulation (EU) No. 10/2011 and Regulation (EU) No. 1935/2004
- "Soft-feel surface and modern appearance
- Slip-resistant and noise-absorbing
- Easy to clean and replace
- Flexible use in all common drawer and cupboard types from 250 to 1200 mm width and 300 to 650 mm depth
- Also available as raw panels in max. format of 1,400 x 2,100 mm
- Can be combined with ELCO cutlery inserts with identical surfaces

## Delivery programme

Version	Sheet goods
Material	ABS / TPU
Widths	Nominal widths 250 - 1200 mm
Depths	Nominal depths 300 - 650 mm
Strength	1 mm
Special designs	on request

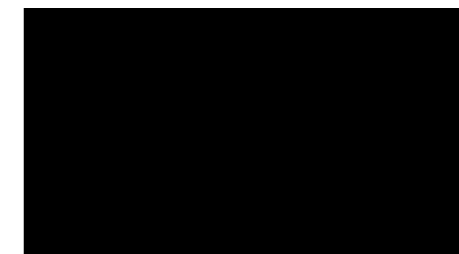

## Colours

Colours	No.
Anthracite	F868
Black	F100
White	F185
More colours	on request



# MAGIC SCRATCH



The subtle and innovative structure of the new anti-slip mat MAGIC SCRATCH looks like a finely ground metal surface. Even the first impression suggests that lines interrupted at a steep angle intersect at irregular intervals. The resulting light reflections create a modern and metallic effect. The valuable feel can be "grasped". The MAGIC SCRATCH series with its non-slip surface is not only an experience to look at and feel, but also promises to protect the floor.

The MAGIC SCRATCH series can be used as far as the eye can see. The series finds its place not only in the kitchen, but also in the living room or in the bathroom. In conjunction with a cutlery insert with the SCRATCH surface, a homogeneous ensemble is created so that the all-in-one product can be used anywhere. The MAGIC SCRATCH series is now available both as panels in standard dimensions or as cuts for frame systems that are common on the market.

- Food safety according to the European Plastics Regulation (EU) No. 10/2011 and Regulation (EU) No. 1935/2004
- Surface like a finely ground metal surface
- Cool clean Look
- Slip-resistant and noise-insulating
- Flexible use in all common drawer and cabinet types from 250 to 1200 mm wide and 300 to 650 mm deep
- Also available as raw sheets in the maximum format of 1,400 x 2,100 mm
- Serial production possible
- Can be combined with ELCO cutlery inserts with an identical surface

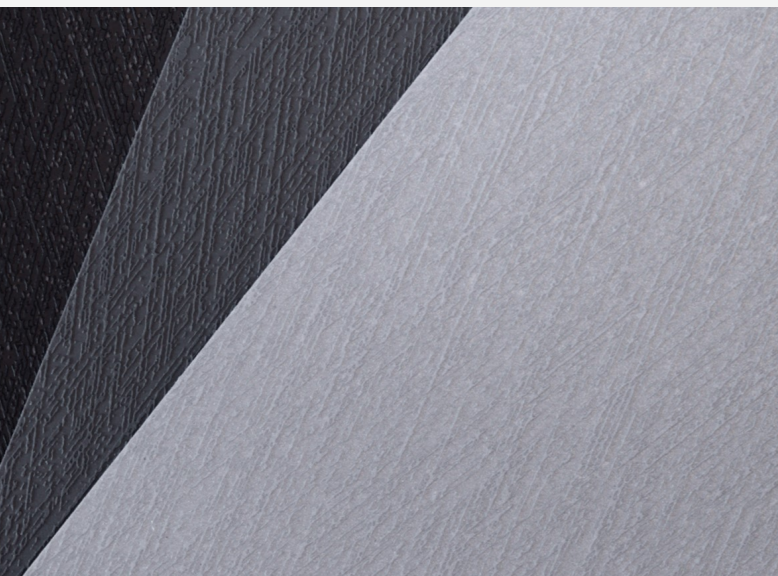

## Delivery programme

Version	Sheet goods
Material	ABS / TPU
Widths	Nominal widths 250 - 1200 mm
Depths	Nominal depths 300 - 650 mm
Strength	1 mm
Special designs	on request



## Colours

Colours	No.
Anthracite	F868
Black	F100
Silver	F867
Other colors	On request

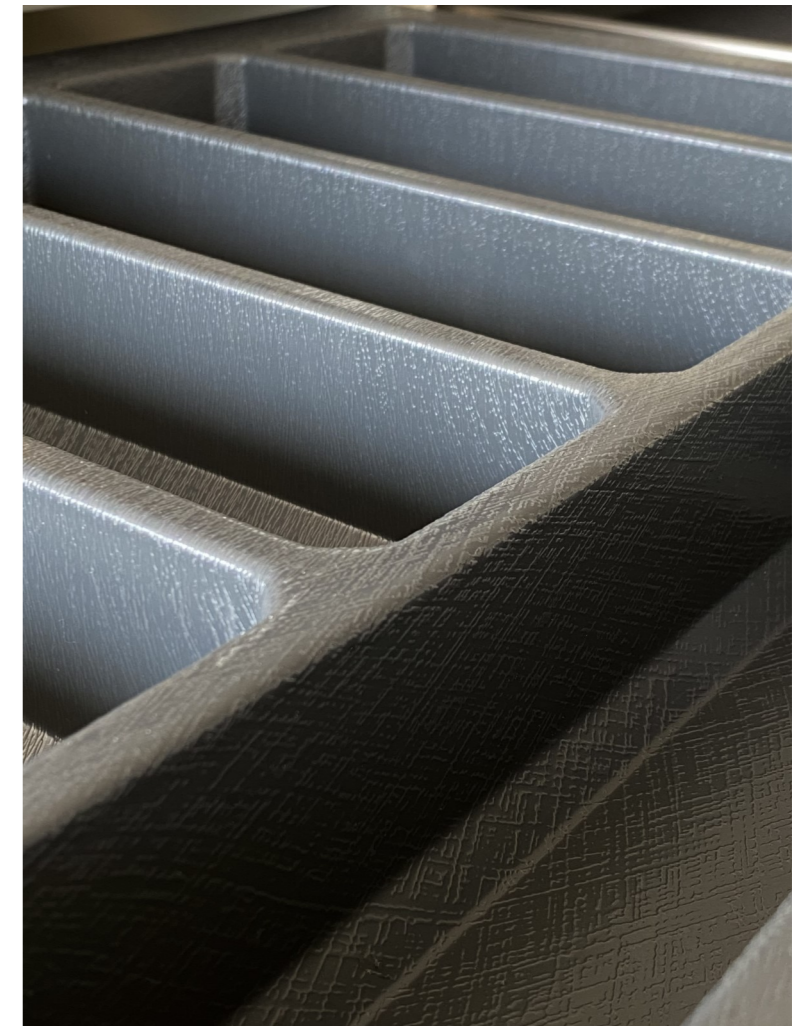

# MAGIC SLIM



## Delivery programme

Version	Sheet goods
Material	PS / TPE
Widths	Nominal widths 250 - 1200mm
Depths	Nominal depths 300 - 650mm
Strength	0,8 mm
Special designs	on request

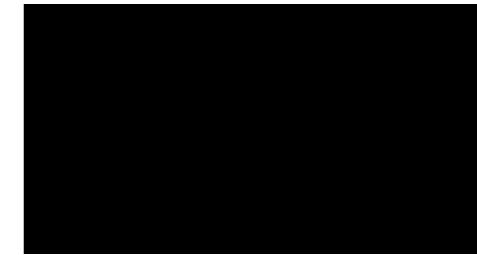

## Colours

Colour	No.
Anthracite	F863
Black	F100
More colours	on request

Modern design coupled with a matt finish - this is what distinguishes the MAGIC SLIM anti-slip mat. When touching the anti-slip surface, it becomes clear that objects are protected from slipping by using the anti-slip mat in the drawer.

The grained surface of the MAGIC SLIM also gives each drawer a particularly high-quality look and protects the base. In combination with a cutlery insert, a harmonious picture is created. The MAGIC SLIM range is available in standard sizes or cut to size for the most common drawer systems on the market.

- Modern look
- Matt finish
- Slip-resistant
- Flexible use in all common drawer and cupboard types from 250 to 1200 mm width and 300 to 650 mm depth
- Also available as unfinished panels in a max. format of 1,400 x 2,100 mm
- Can be combined with ELCO cutlery inserts



# TOP ROLL GROOVE

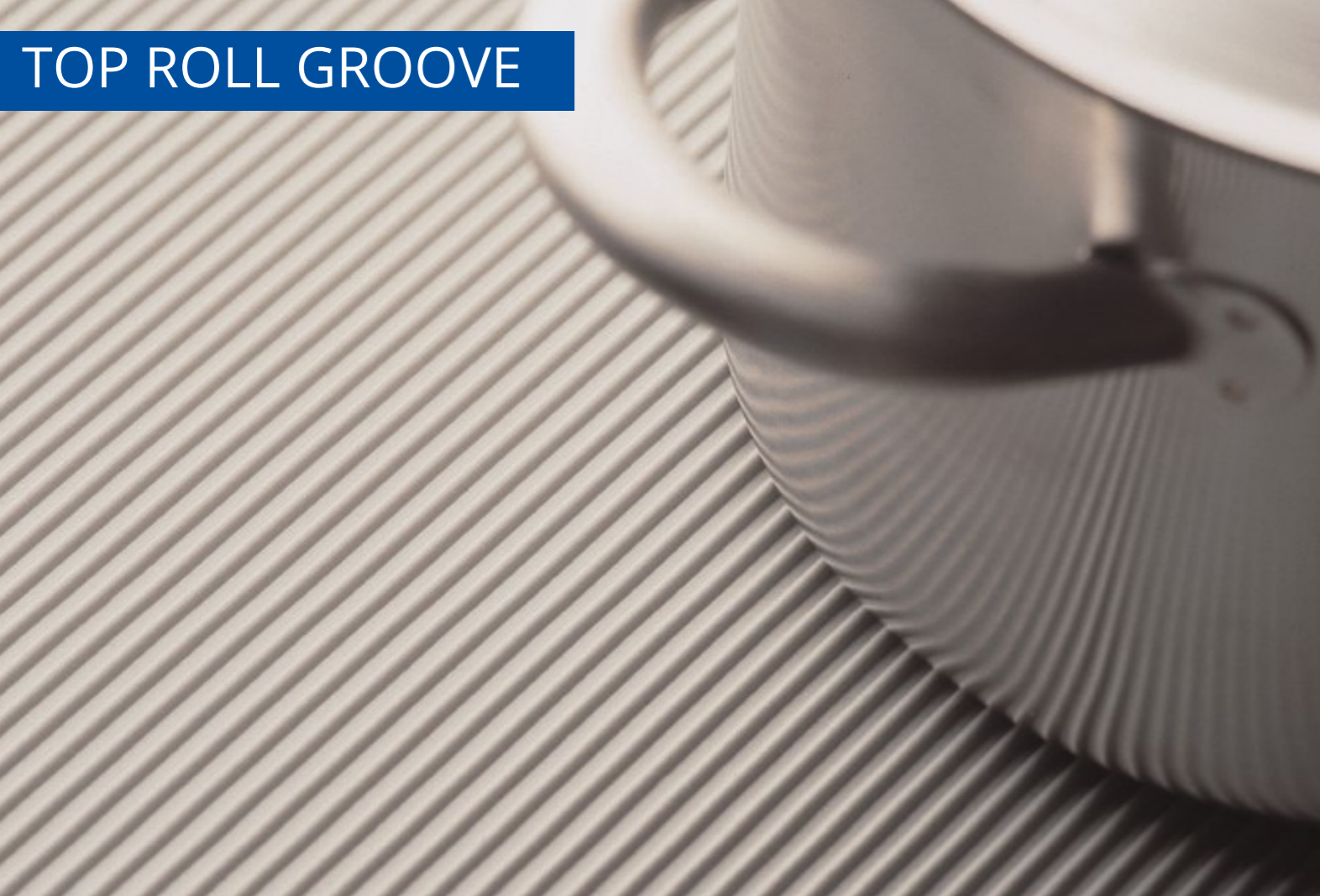

Functional design and an anti-slip surface define the TOP ROLL GROOVE anti-slip mat. The groove-like structure of the surface protects the objects in the drawer from slipping. The TOP ROLL GROOVE anti-slip mat is also suitable for making up on its own. The TOP ROLL GROOVE series is available as roll material in standard dimensions or cut to size for common drawer systems on the market.

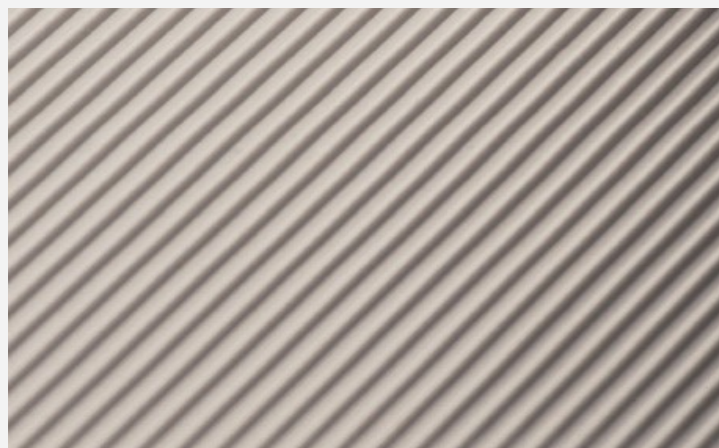

- Non-slipping
- Functional design
- Flexible use in all standard drawer and cupboard types from 250 to 1200 mm wide and 300 to 650 mm deep
- Also available in rolls (roll goods)
- Can be combined with ELCO cutlery inserts

## Delivery programme

Version	Roll goods
Material	PS / TPE
Nominal widths	500 - 1500
Strength	1,5
Special designs	on request
Other dimensions and fixed dimensi-	on request

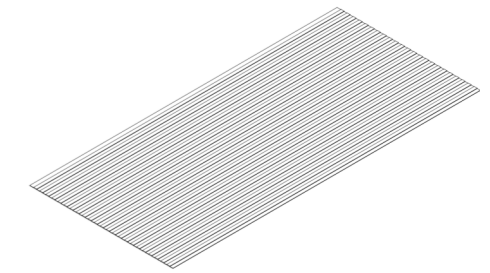

## Colours

Colours	No.
Black	F100
Other colours	on request



## ELCO Accessories & Additional



# SOCKET ENCLOSURE



With or without? The completely pre-assembled socket outlet housings are available in different versions with or without switch. In addition, you can choose between 1-gang and 2-gang enclosures and whether with or without transformer. Simple elegance. In the standard colours white/white and silver/black, the recessed socket outlet housing fits perfectly into any corner. The attractive design also offers something for the eye. Strong inner life. The high-quality system components complete the high ELCO quality.



## Delivery programme

Article no.	Colour	Number of socket	Unit switch for outgoing line	Length with ferrules	Supply line
10101 170.002	White/white	1	1 x HO 5,2x0,75	1,50 m	HO 5,3x1,5
10101 840.002	Silver/black	1	1 x HO 5,2x0,75	1,50 m	HO 5,3x1,5
10101 170.001	White/white	1	-	1,50 m	HO 5,3x1,5
10101 840.001	Silver/black	1	-	1,50 m	HO 5,3x1,5
10103 170.002	White/white	2	1 x HO 5,2x0,75	1,50 m	HO 5,3x1,5
10103 840.002	Silver/black	2	1 x HO 5,2x0,75	1,50 m	HO 5,3x1,5
10103 170.001	White/white	2	-	1,50 m	HO 5,3x1,5
10103 840.001	Silver/black	2	-	1,50 m	HO 5,3x1,5

Dimensions 1-fold housing (H/W/D) 98/70/74 mm

Dimensions 2-fold housing (H/W/D) 98/142/74 mm

Material (casing) ABS

Minimum order 1 packaging unit

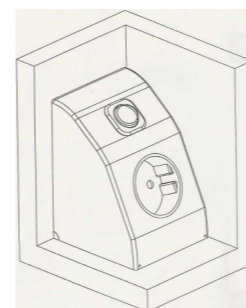

1 socket with switch

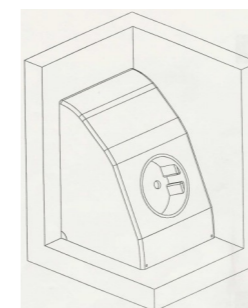

1 socket

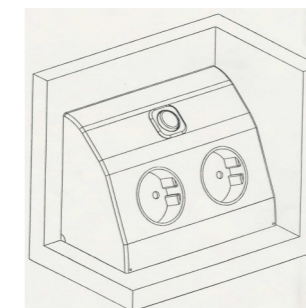

2 sockets with switch

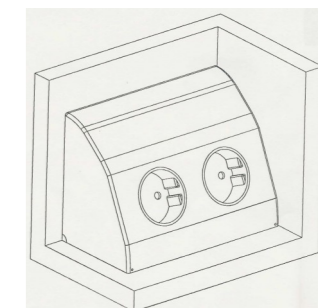

2 sockets

## Colours

### Colour

White/white F170

Silver/black F840

Other colours on request

# PLASTIC GUIDES



Guide rails for connecting, without locking



Guide rails to screw on, without locking



Guide rails for dowelling, without locking



Guide rails for connecting, with locking device



Guide rails to the dowel, with locking device



Roller guides

Guide rails for drawers are important functional elements in furniture construction. We are specialists in these articles. Many years of experience, a wealth of ideas, advanced technology and the use of high-quality raw materials are the basis for the quality of our products and our market position. The mature and market-recognised programme enables us to produce large series, which is why we deliver from stock at short notice and offer favourable prices.

Our guide rails are not only ideally suited for our entire drawer systems, but also for third-party products. This data sheet shows the latest status of our plastic guide systems product group. We are constantly developing further in order to be able to offer the market ever new and better problem solutions.



R050184, System guide rail

- Guides with and without locking device
- Internal or external locking prevents the drawer from falling out when pulled out
- All locking and rolling slides are supplied as a set (left/right)

## CONNECTING without locking

Article no.	L	H	D
R050726	280	16	6
R050197	280	16	8
R050708	280	16	9
R050198	280	16	10
R050709	280	16	12,5
R050724	280	16	13,4
R050710	280	16	14,4
R050711	280	16	16
R050725	280	16	18,6
R050199	280	11	20

## DOWEL without locking

Article no.	L	H	D
R050165	285	16	8
R050749	340	16	8
R050701	300	16	10
R050753	300	16	13,4
R050873	300	16	16
R050702	300	10	20

## DOWEL with locking

Article no.	L	H	D
R050842	255	13,7	8
R050752	285	13,7	8
R050792	285	13	8
R050836	375	13	8
R050764	285	13,7	10
R050722	285	13,7	13,4
R050882	285	13	16
R050788	375	13	22

## FURNITURE

Article no.	Description
R050184	System guide rails, plus system bracket R010094
R050163 / R050715 / R050716	Wire basket guide rails, (X/Y) = (total height/utility): R050163 (26/16), R050715 (24/14), R050716 (18/8)
R050767	Guide rails for screwing underneath without and with locking device R010958

## TIGHTENING without locking

Article no.	L	H	D
R050164	285	16	8
R050863	368	16	8
R050176	450	16	8
R050190	270	16	9
R050864	368	16	9
R050166	350	16	16
R050167	350	16	24

## CONNECTING with locking

Article no.	L	H	D
R050748	255	13,7	8
R050738	285	13,7	8
R050744	285	13,7	10
R050852	340	13,7	10
R050774	375	13	12
R050874	285	13	16
R050739	Drawer stopper for third-party manufactures		

## ROLLING GUIDES

Article no.	Description	with/without Locking
R050707	With riveted plastic Roller R050189	Without locking
R050703	With loosely attached plastic castor R050189	With external locking
R050192	Spacer strip for dimension increase of article R050703	-
R050704	Special screw 4.0x25 mm for Article R050703	-
R050705	Special screw 4.0x33 mm for article R050703 in connection with spacer with spacer strip R050192	-



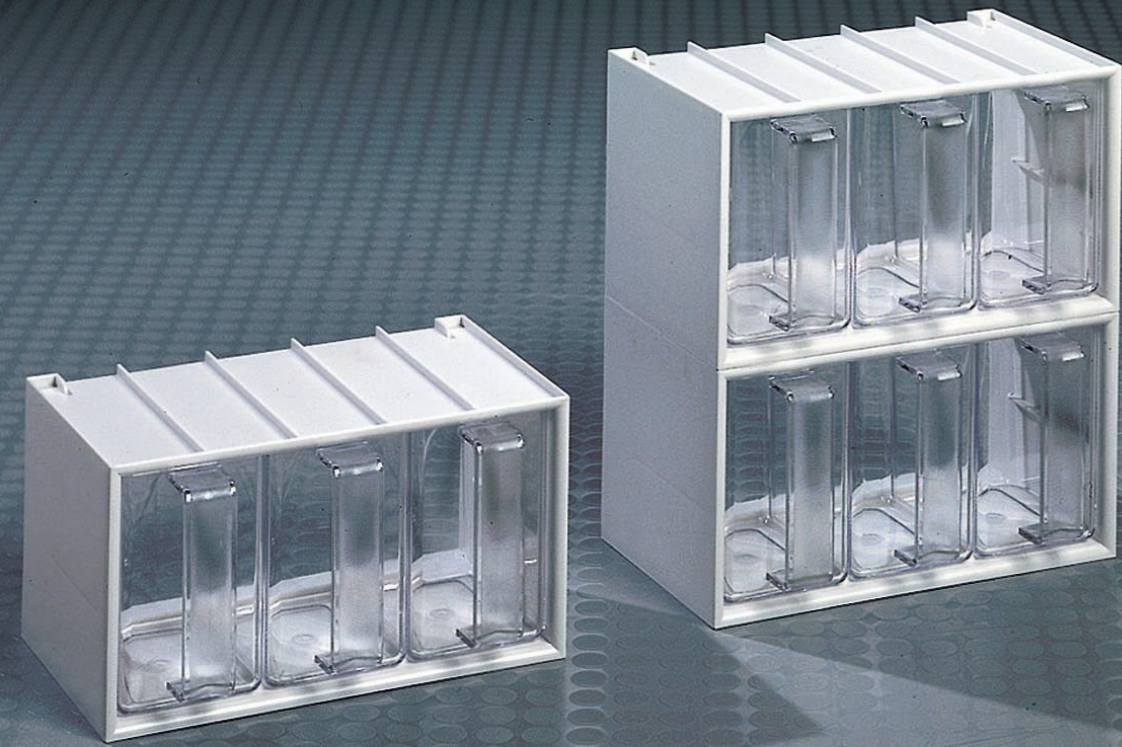

The chute LUXUS - the high-quality version from the ELCO chutes range. With the large number of possible variations of a sophisticated modular system in a contemporary design. Ideal use in 300 mm wide wall units with 16 mm thick sides. Further accessories: ELCO KITCHEN CONTAINER - ideal storage and work container.

They are preferably used in shelf pull-outs and are used to store fruit, vegetables and other foods. A practical addition to the kitchen interior. All 3 sizes can be combined with each other. Same sizes are stackable. This results in more sorting options. Can be used in all corpuse widths and shelves.



- High-quality raw materials make the chute top-quality products
- Since all parts can be easily connected to each other, every cabinet height can be optimally used
- Other variants on request
- Accessories: Welded cover plate on the chute housing for a clean finish and additional storage space
- Spreader panels, each 25 mm wide, are available for use in 350 mm wide wall units

## CHUTES

Article no.	H Case		Chutes
	C013503	C013504	
C013010	146	1	3
C013020	292	1	6
C013030	438	1	9

Article no.	Description	W	D	H
C013503	Case for 3 chutes	267	150	146
C013504	Case for 6 chutes	267	150	292

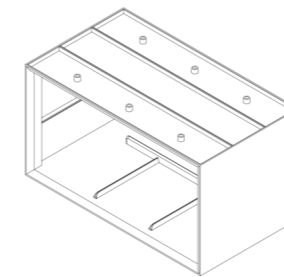

Case for 3 chutes

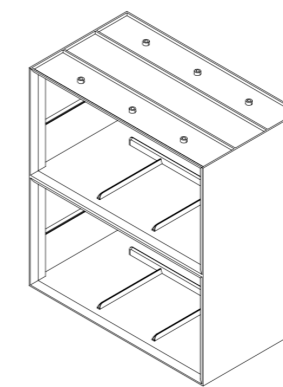

Case for 6 chutes

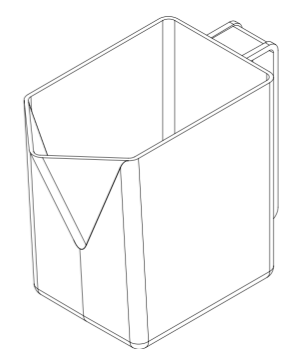

Narrow chute with grip

## Colors

Case	Chutes
Pure White (F174)	Crystal Clear (F102)
Cream White (F176)	Pure White (F174)
	Green-transparent (F103)
Other colors on request	Other colors on request



Furniture plinths and tall units: All vents have an air flow of more than 190 cm<sup>2</sup> and meet the requirements of the appliance industry. The fixing bracket D010535 for the ventilation grilles D010531 and D010533 covers the material thicknesses of 29 - 40 mm. The fixing bracket D010532 for the ventilation grilles D010531 and D010533 can be used for material thicknesses of 10 - 22 mm. Room doors: Free air passage over 210 cm<sup>2</sup>. The vents can be used according to DIN 18017 and comply with the "Technical Rules for Gas Installations" (DVGW-TRGI).



FURNITURE PLINTHS / APPLIANCE TALL CABINETS

COLOURS

Article no.	Depth / Thickness	Packaging unit
D010530	13 mm depth	150 pcs. per colour
D010531	22 mm depth	100 Stk. per colour
D010533		102 Stk. per colour
D010536	10 mm	104 Stk. per colour
D010537	13 mm	104 Stk. per colour
D010538	For 16 mm plinth thick-	104 Stk. per colour

- COLOURS**
- F100 = black
  - F121 = grey RAL7035
  - F170 = white
  - F220 = brown RAL8014
  - F223 = light oak
  - F231 = rustic oak
  - Other colours on request

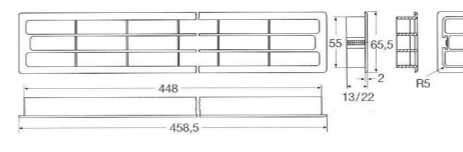

D010530 / D010531

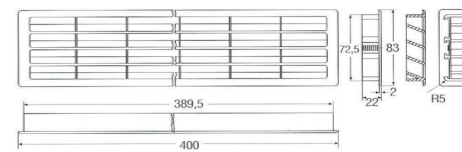

D010533

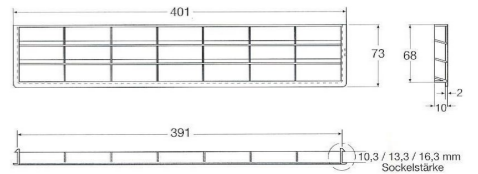

D010536 / D010537 / D010538

ROOM DOORS

Article no.	Packaging unit
104xxx	20 pcs. in a carton

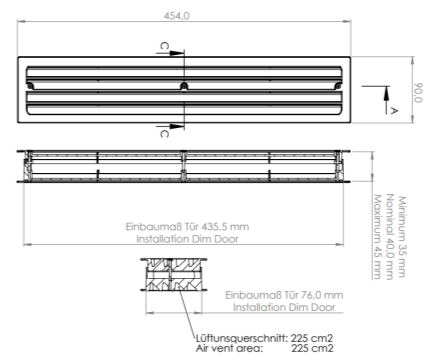

COLOURS

- COLOURS**
- F100 = black
  - F120 = grey
  - F174/F170 = white
  - F220 = brown
  - F840 = silver lacquered
  - Other colours on request

FURNITURE

Article no.	Dimensions in A,B,C,D	Standard colours	Packaging unit
D010521	Drawing	F170, F220, F840	100 St. in a carton
D010524	Drawing	F170, F220	100 St. in a carton
D010527	146, 140, 41, 35	F170, F220, F840	100 St. in a carton
D010528	176, 170, 41, 35	F170, F220, F840	100 St. in a carton
D010529	226, 220, 66, 60	F170, F220, F840	100 St. in a carton

COLOURS

- COLOURS**
- F170 = white
  - F220 = brown
  - F840 = chrome plated
  - Other colours on request

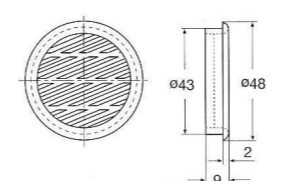

D010521

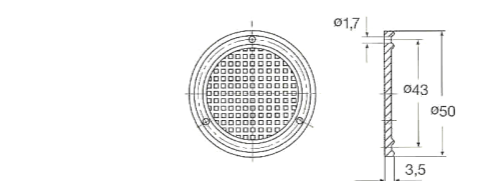

D010524

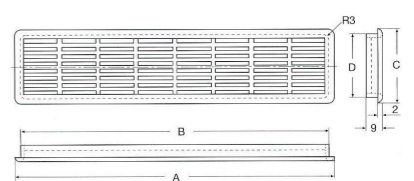

D010527 / D010528 / D010529